



# Electron microscopy

Peter Nagy  
([peter.v.nagy@gmail.com](mailto:peter.v.nagy@gmail.com))

Department of Biophysics and Cell  
Biology, University of Debrecen



## Why do we need electron microscopy?

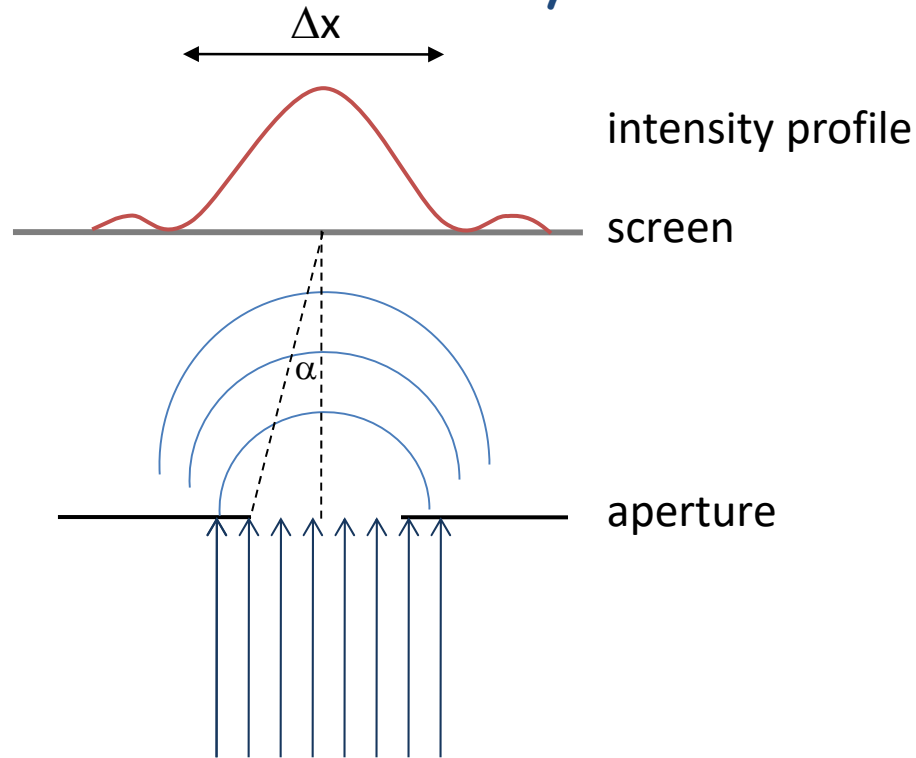

The image of an aperture exposed to light will be larger than the diameter of the aperture due to diffraction (Rayleigh criterion):

$$\Delta x \approx \frac{0.6\lambda}{\sin \alpha}$$

The modification of the above equation according to Abbe is used for defining **resolution** ( $d$ ) in light microscopy:

$$d \approx \frac{0.6\lambda}{n \sin \alpha} = \frac{0.6\lambda}{NA}$$



Two point like objects are separable if their distance is larger than  $\Delta x$ , which corresponds to approx.

$$\frac{0.6 \times 400 \text{ nm}}{1.2} = 200 \text{ nm}$$

in **light microscopy**.

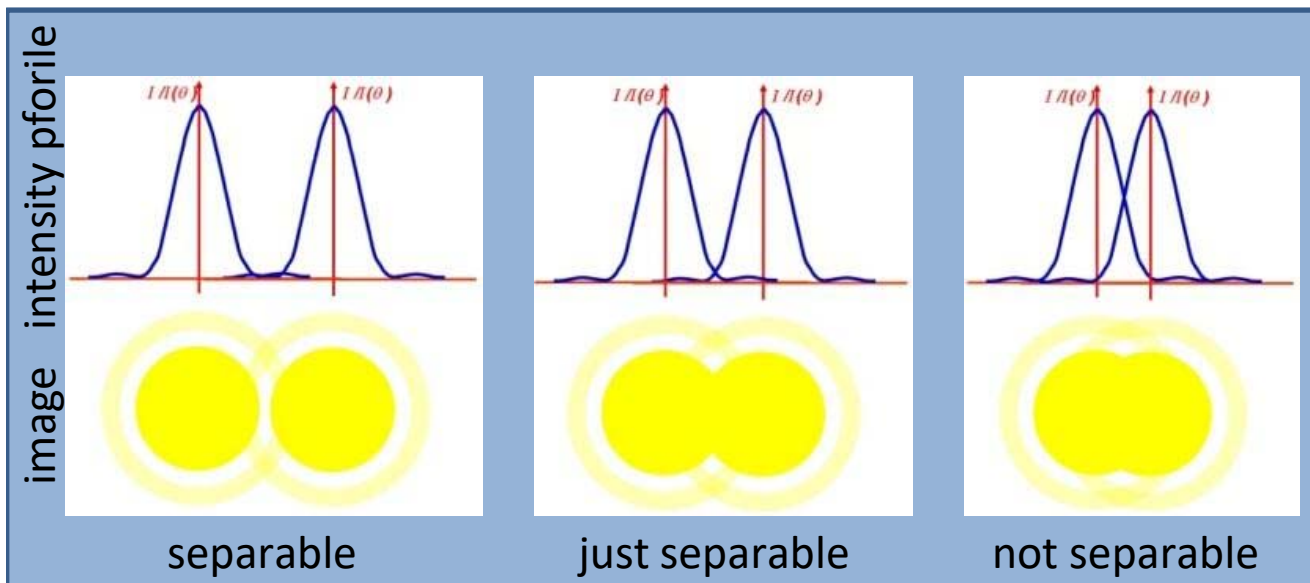

## Why do we need electron microscopy?

The resolution of **conventional light microscopy** cannot significantly exceed, i.e. be lower than 200 nm.

$$d \approx \frac{0.6\lambda}{n \sin \alpha} = \frac{0.6\lambda}{NA}$$

Numerical aperture cannot significantly increase beyond 1.

several technical obstacles prevent us from using wavelengths below 400 nm:

- **in the UV range** special lenses are required, and this modification results in a max. 2-fold improvement in resolution
- radiation with even lower wavelength (**X-ray**) cannot be focused with lenses
  - special Fresnel zone plates (diffraction plates) are required for focusing X-rays
  - generation of X-rays and construction of an X-ray microscope are costly

## Why do we need electron microscopy?

According to Louis de Broglie, a French physicist, a wave can be assigned to each elementary particle whose wavelength is given by the following equation:

$$\lambda = \frac{h}{p}$$

Derivation of the de Broglie equation from the quantum theory of light and from Einstein's theory of special relativity:

Einstein's equation

$$E = hf = h \frac{c}{\lambda}$$

$$E = mc^2$$

$$h \frac{c}{\lambda} = mc^2 \Rightarrow \frac{h}{\lambda} = mc \Rightarrow \frac{h}{\lambda} = p$$

momentum of the photon  
( $p=mv$ )

According to the de Broglie equation the wavelength assigned to an elementary particle is inversely proportional to the momentum of the particle: **fast particle** → **short wavelength**

Kinetic energy of an electron accelerated in an electric field:  $E_{kin} = eU$

$$E_{kin} = \frac{1}{2}mv^2 = \frac{p^2}{2m}$$

$$p = \sqrt{2mE_{kin}} = \sqrt{2meU}$$

Wavelength of an accelerated electron:

$$\lambda = \frac{h}{p} = \frac{h}{\sqrt{2meU}} \approx \frac{1.23 \text{ nm}}{\sqrt{U}}$$

Sub-nanometer wavelength and resolution can be achieved using small acceleration voltages.

## Physical resolution of an electron microscope

$$\left. \begin{aligned} \lambda &= \frac{1.23}{\sqrt{U}} \text{ nm} \\ d &= \frac{0.6\lambda}{n \sin \alpha} \end{aligned} \right\} d = \frac{0.6 \cdot 1.23}{n \sin \alpha \sqrt{U}} \approx \frac{0.74}{\alpha \sqrt{U}} \text{ nm}$$

The half angle of lenses in electron microscopes is small,  $\alpha \sim 0.01$  rad.  
The index of refraction is  $\approx 1$ .

Therefore, the resolution at an accelerating voltage of 10000 V is:

$$d = \frac{0.74}{0.01\sqrt{10000}} = 0.74 \text{ nm}$$

# Types of electron microscopes

## Transmission electron microscope (TEM)

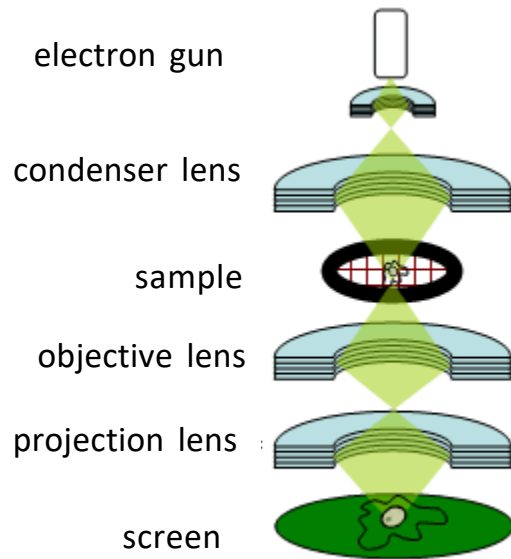

The sample is imaged at once, similar to a conventional light microscope, but electrostatic or magnetic lenses are used instead of optical lenses.

## Scanning electron microscope (SEM)

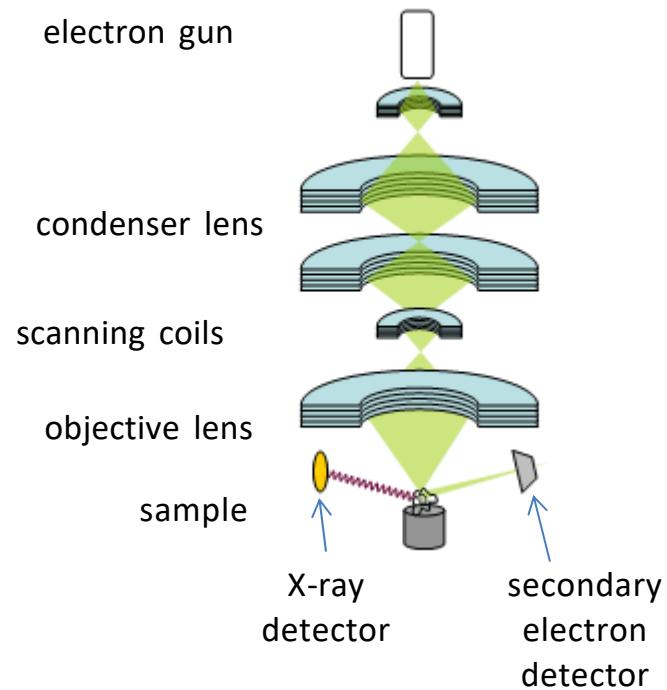

X-rays or secondary electrons induced from single pixels of the sample are detected followed by scanning across the whole sample.

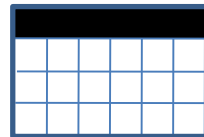

## Scanning transmission electron microscope (STEM)

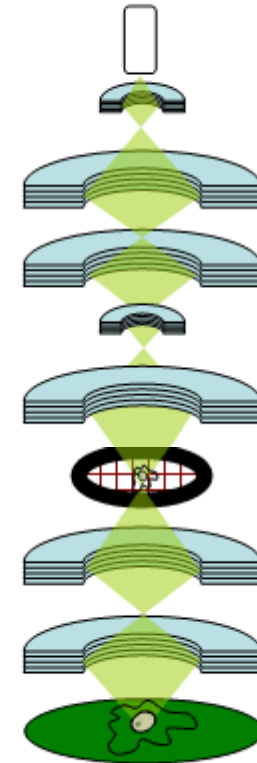

Mixture of SEM and TEM:

- scans pixelwise
- but detects transmitted radiation

# Comparison of electron and light microscopes

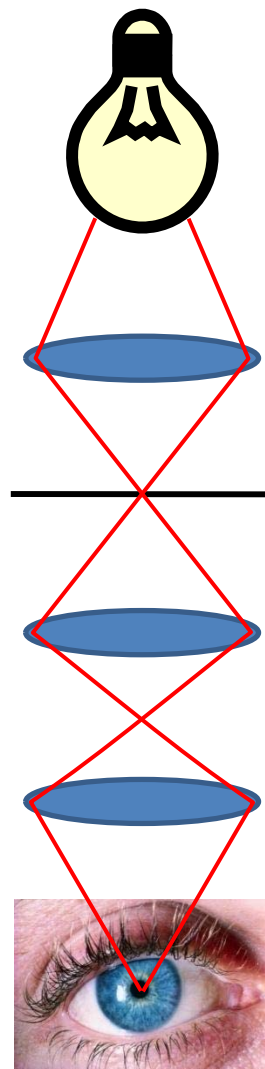

light microscope

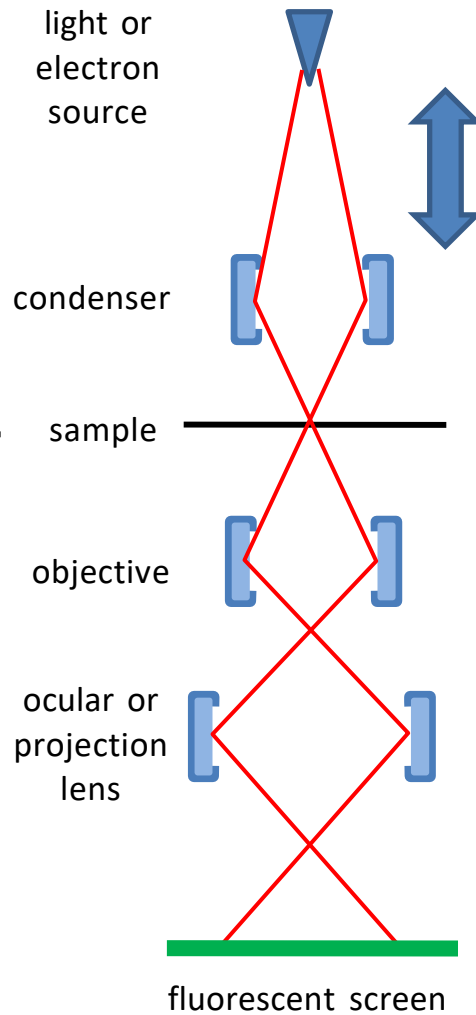

TEM

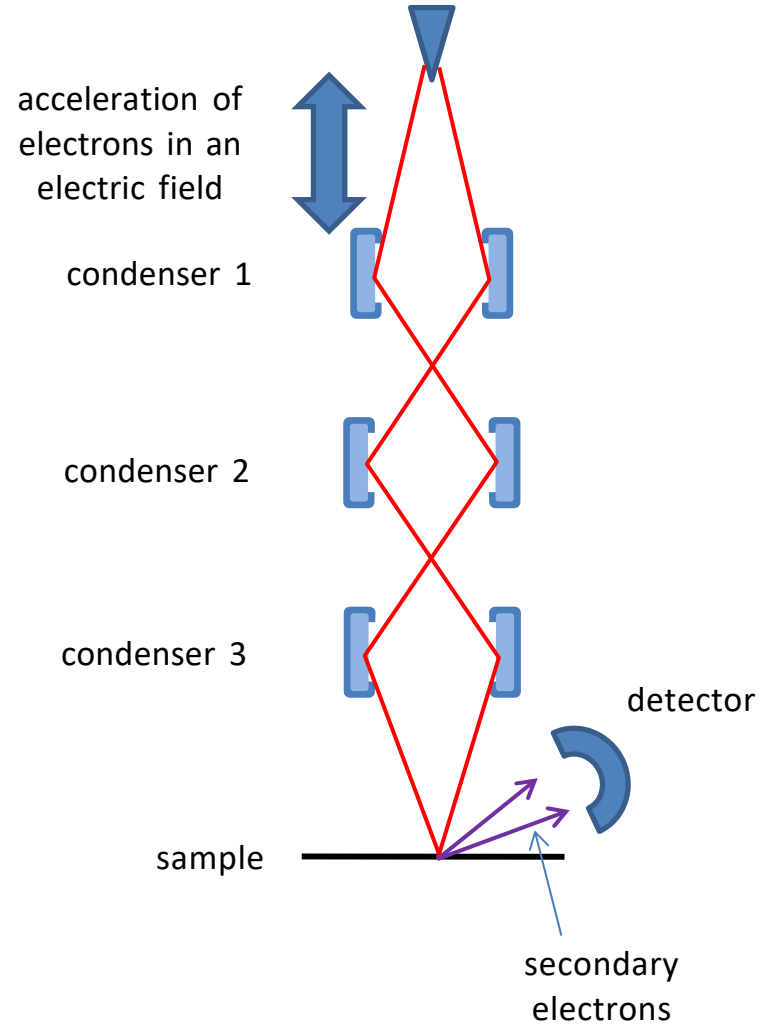

SEM





## Acceleration of electrons

Electrons are accelerated to high speeds as a result of large voltages.

According to the work-energy theorem the work done by the electric field ( $eU$ ) increases the kinetic energy of the electron:

$$eU = \frac{1}{2} m_0 v^2 \quad \begin{array}{l} e - \text{charge of electron, } U - \text{accelerating voltage,} \\ m_0 - \text{rest mass of electron, } v - \text{velocity of electron} \end{array}$$

Since the speed of electrons approaches the speed of light, the relativistic equation must be used instead of the above one, which takes the increase of the mass of the electron into account:

$$eU = \frac{m_0 c^2}{\sqrt{1 - v^2/c^2}}, \quad \gamma = \frac{1}{\sqrt{1 - v^2/c^2}} \Rightarrow eU = \gamma m_0 c^2 \quad \begin{array}{l} c - \text{speed of light} \\ \gamma - \text{relative increase in mass} \end{array}$$

U (kV) or E <sub>0</sub> (keV)	γ	v/c	1/2m <sub>0</sub> v <sup>2</sup> (keV)
100	1.2	0.55	77
200	1.39	0.7	124
300	1.59	0.78	154
1000	2.96	0.94	226

The largest fraction of the energy is used for increasing the mass.

# Electron optics

## 1. Electrostatic lens:

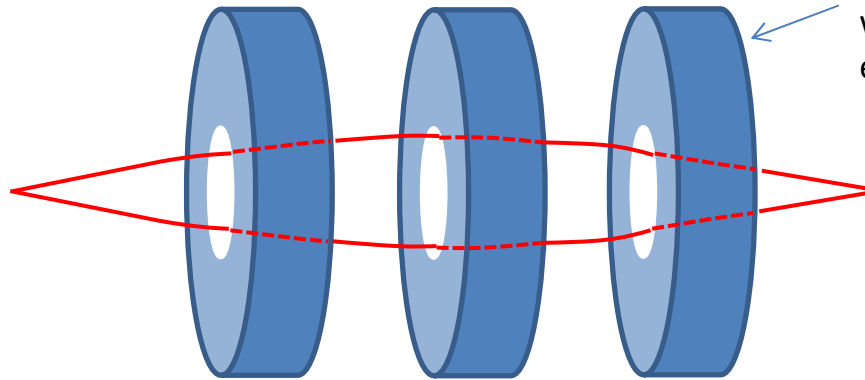

circle-shaped, negatively charged electrodes with a cavity in the middle, which deflect the electrons toward the middle.

## 2. Magnetic lens: The magnetic field is generated by coils. The direction of magnetic Lorentz force is perpendicular to both the magnetic field and the velocity of the particle:

$$F = Bqv \sin \alpha$$

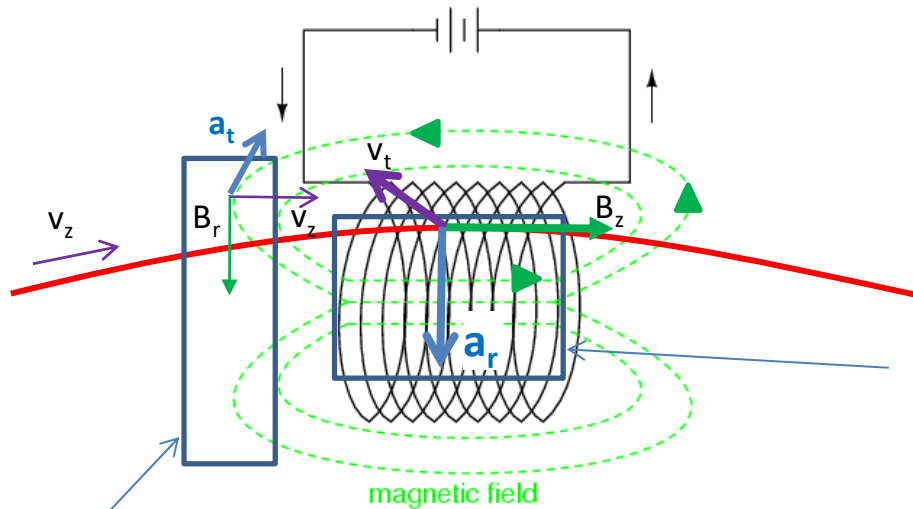

the radial direction is perpendicular to both the magnetic field directed along the z axis and the tangential component of the velocity → the electron is accelerated toward the middle of the coil



- the direction of the magnetic field is mainly along the z axis
- the magnetic Lorentz force does not act on the z component of the velocity ( $\sin \alpha=0$ ), but the velocity has a tangential component as well

- the direction of the magnetic field is mainly radial
- the direction of the velocity is mainly parallel to the axis of the coil (z direction)

the direction perpendicular to both directions is tangential → the electron will be deflected tangentially.

# Imaging aberrations

Images generated by electron lenses do not meet all the requirements of perfect imaging, similar to optical lenses:

1. A single image point corresponds to a single object point.
2. The pattern of image points shall be similar to the pattern of object points.
3. The focal length of the objective shall not be dependent on the distance.

**The most important imaging aberrations** of electron lenses:

1. Spherical aberration: electrons at different distances from the axis are focused to different points.

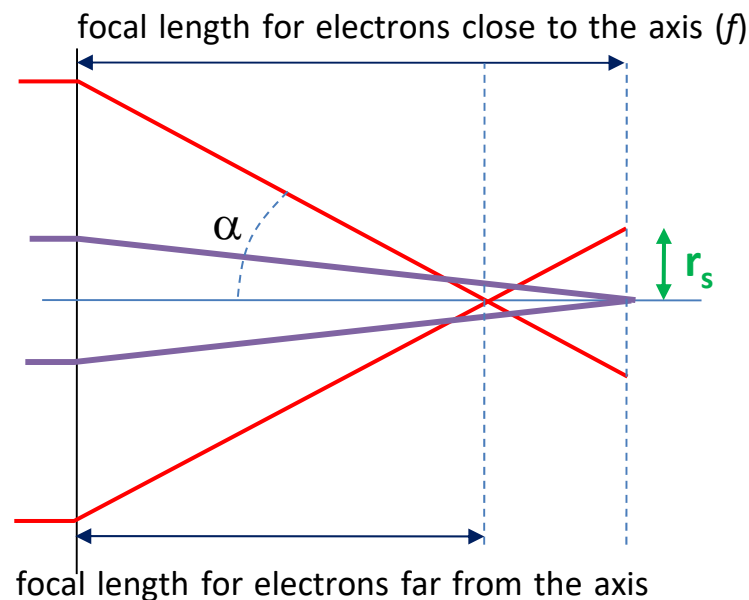

$$r_s = cf^2 a^3 = C_s a^3$$

1. Spherical aberration is proportional to the cube of the half angle of the lens ( $\alpha$ ).
2. The stronger the lens (small  $f$ ), the smaller spherical aberration is.
3. The focal length can be decreased by increasing the lens current.

## Imaging aberrations

The most important imaging aberrations of electron lenses:

2. Chromatic aberration: electrons with different speeds (different wavelength, different “color”) are focused to different points.

The dispersion of electron speed is caused by the following:

1. Electrons are emitted with different speeds from the cathode.
2. Fluctuation of the acceleration voltage.
3. Loss of kinetic energy due to inelastic scattering.

$$r_c = \alpha f \frac{\Delta E_0}{E_0}$$

1. Chromatic aberration is proportional to the half angle of the objective.
2. Chromatic aberration is proportional to the focal length
3. ... and it is inversely related to the kinetic energy of electrons ( $E_0$ ).

The magnitude of both spherical and chromatic aberration can be decreased by increasing the strength of the lens (decreasing  $f$ ).

## Imaging aberrations

The imaging aberration typical of magnetic lenses is **image rotation**.

Image rotation is the consequence of the tangential acceleration of electrons entering the coil.

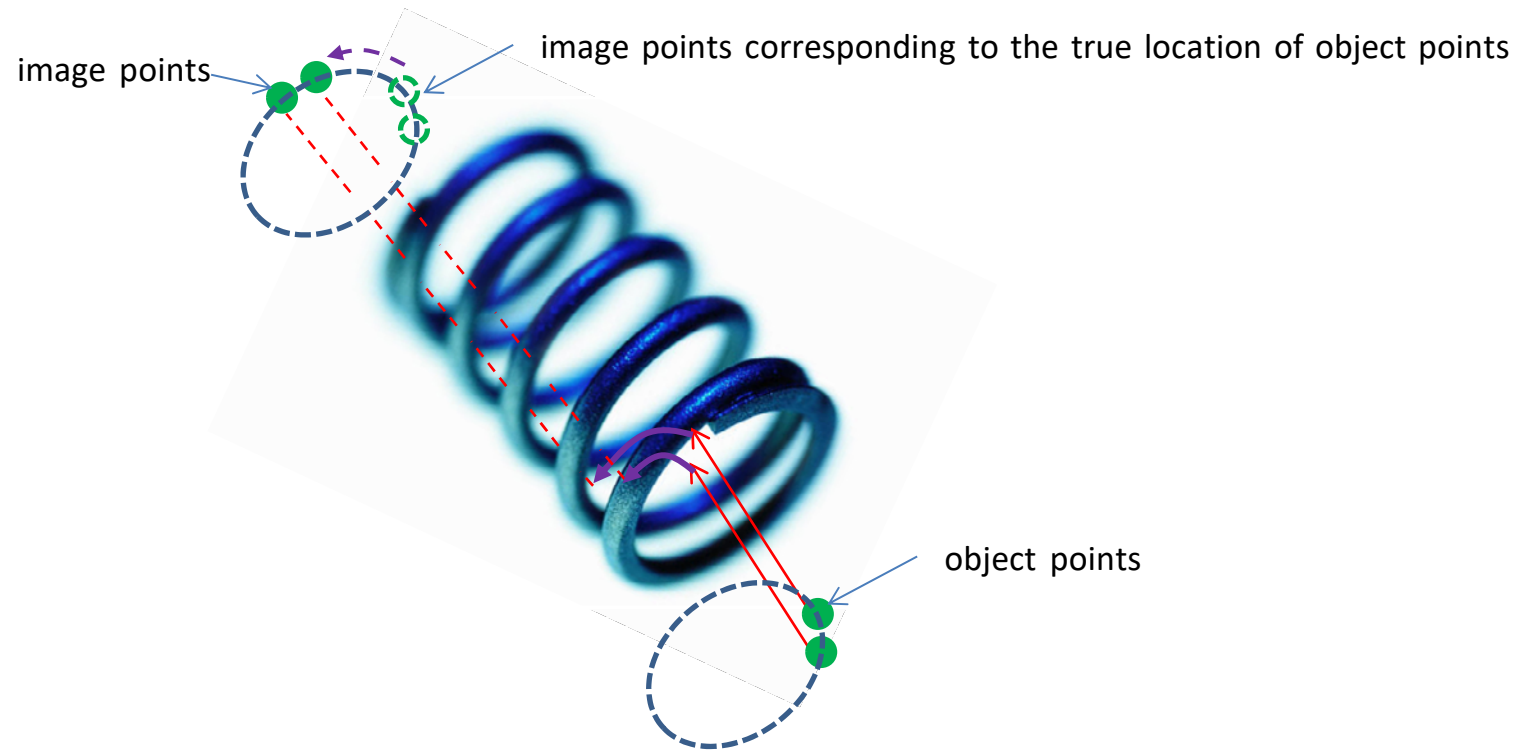

## Comparison of electrostatic and magnetic lenses

Advantages of electrostatic lenses	Advantages of magnetic lenses
No image rotation	Imaging aberrations are less significant
Low energy requirement, simple	No need for high voltage
No need for a very stable power source	They can be applied as immersion lenses
Ions can also be focused	

Electron lenses have a large depth of field, i.e. layers at different distances from the lens are in focus.

# Vacuum

In an electron microscope, especially in a TEM, vacuum must be generated in order to prevent

- scattering of electrons
- discharges between high-voltage components.

Methods and tools for generating vacuum:

## 1. Rotary vane pump

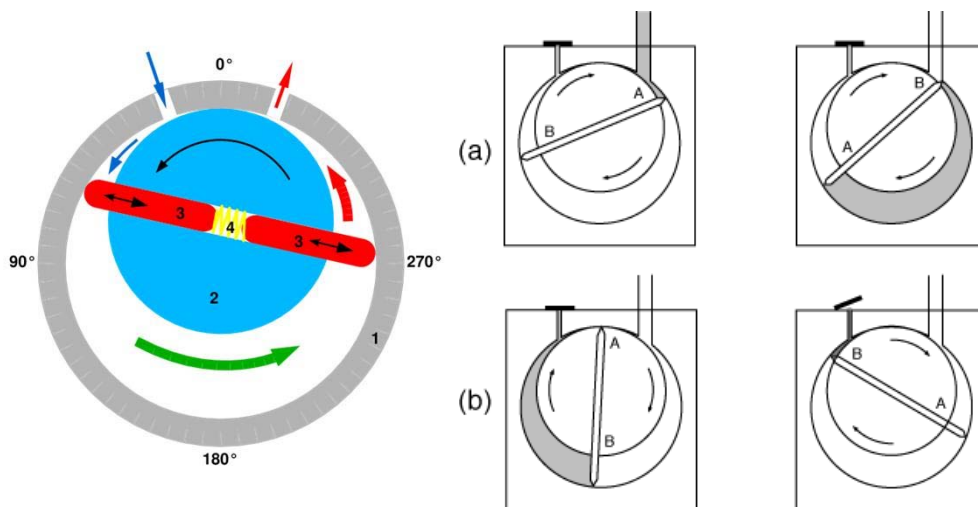

Rotation of the piston with an eccentric axis of rotation sucks air in (blue arrow), compresses it (green arrow) followed by pumping it out (red arrow).

## 2. Diffusion pump

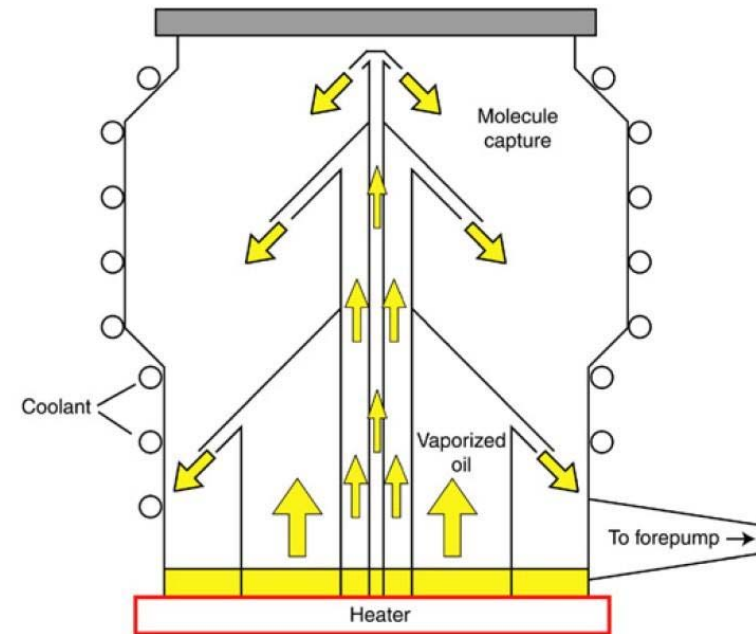

Oil evaporates followed by its downward flow due to the downward air stream. Oil particles deflect gas molecules downward due to their collision. Therefore, the concentration of gas molecules decreases in the top part. Oil is condensed as a result of collision with the cold wall of the pump.

# Vacuum

Methods and tools for generating vacuum:

3. Turbomolecular pump



High-speed turbine

4. Ion pump

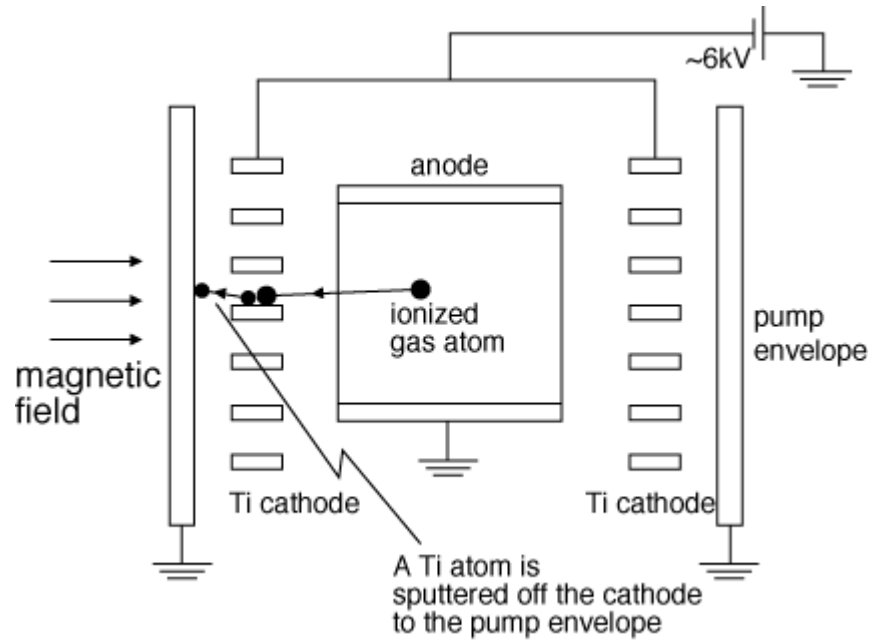

Discharges between electrodes ionize gas molecules and ionized gas particles collide into the electrodes.



# Interaction of electrons with the sample in TEM

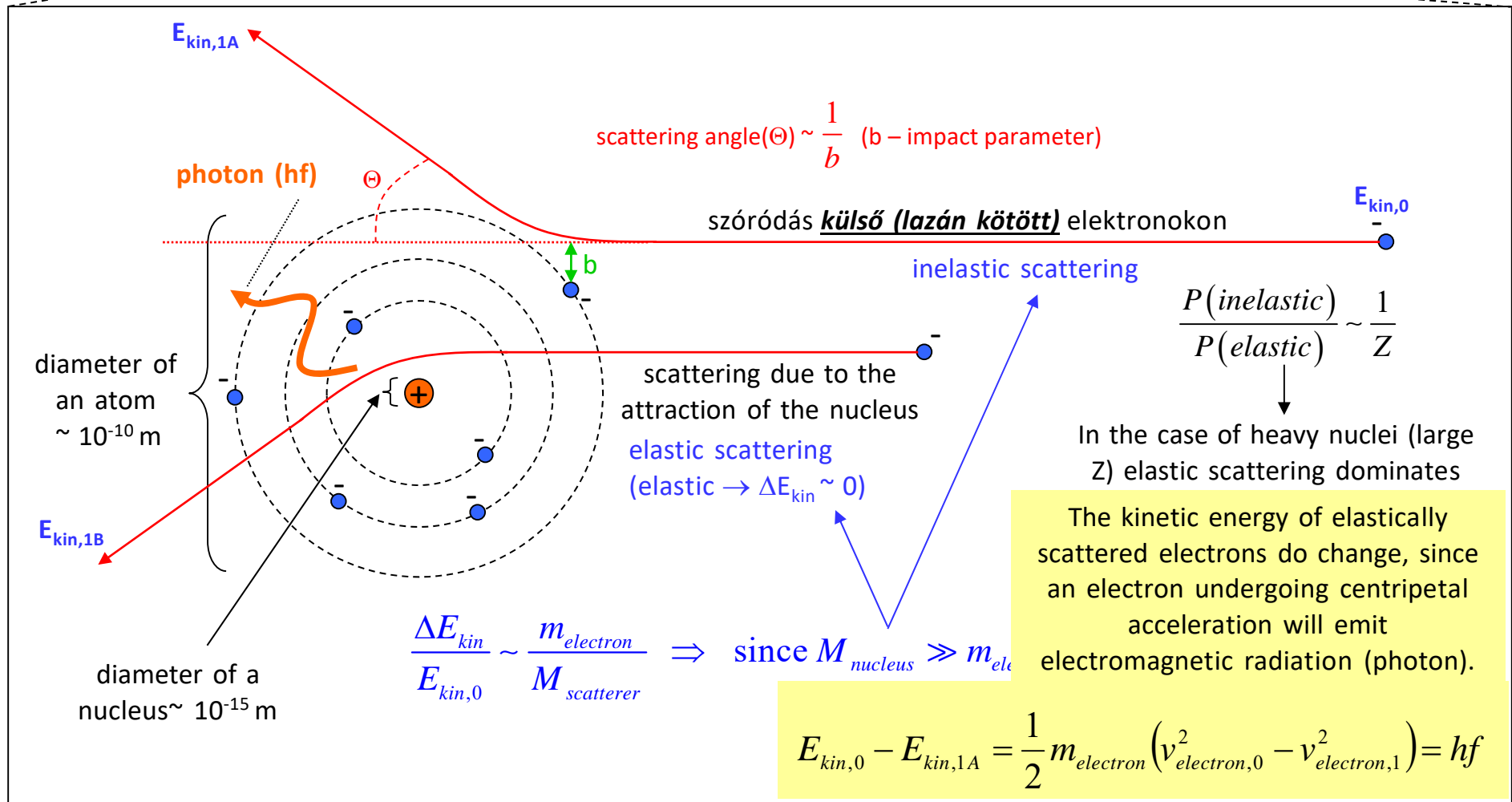
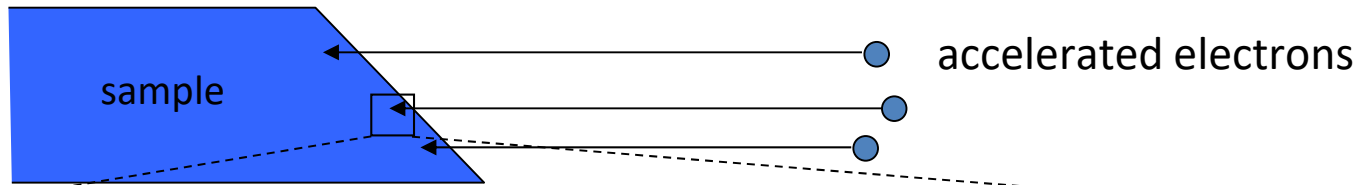

# Generation of contrast in TEM. What do we see in a TEM image and why?

In a light microscope (not phase or interference contrast) mainly absorption is responsible for contrast generation:

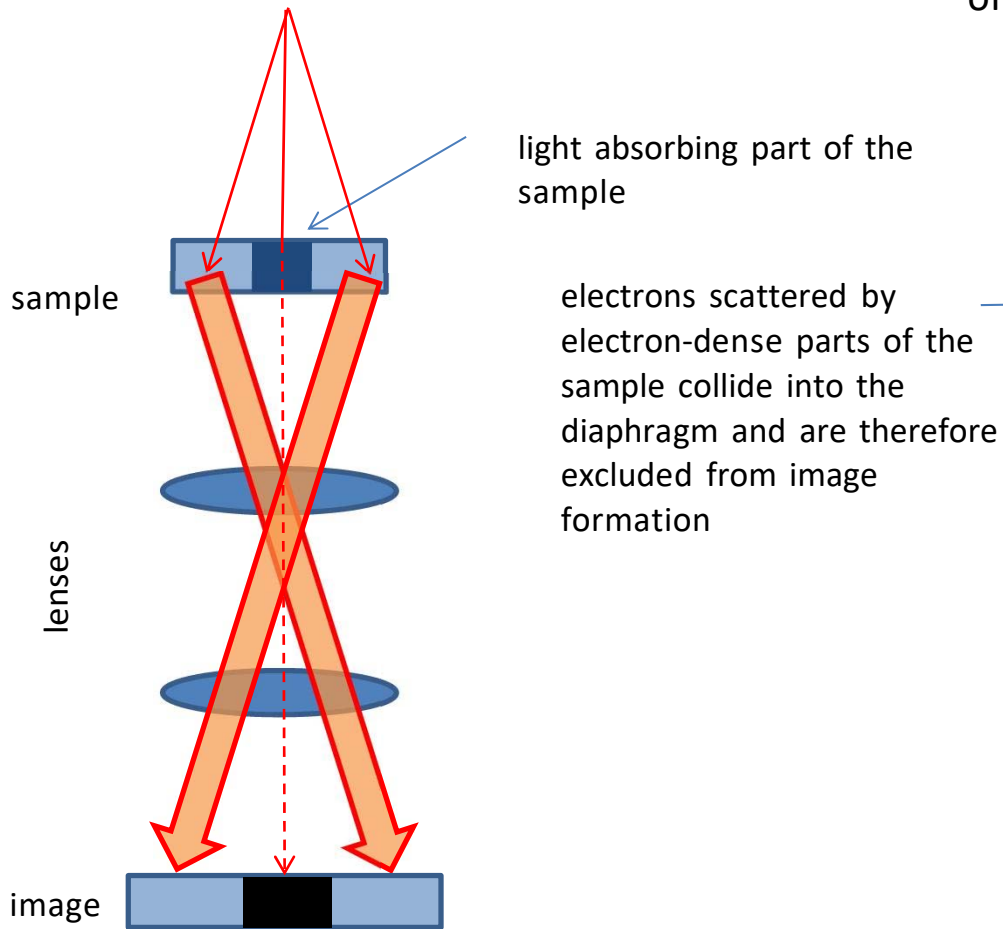

Electrons are not absorbed, but scattered in the sample in an electron microscope. In TEM the most important contrast generating mechanism of scattering (**scattering contrast**).

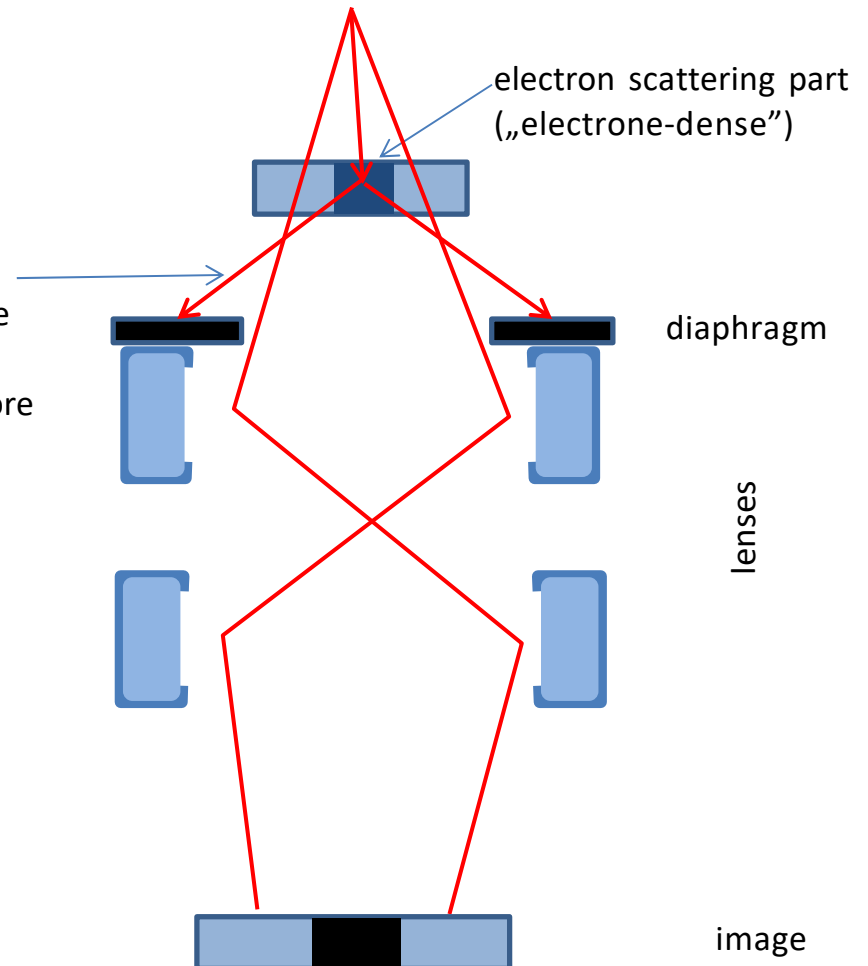

# Generation of contrast in TEM. What do we see in a TEM image and why?

1. Scattering contrast: electrons scattered at a large enough angle do not reach the detector.
  - A. Thickness contrast: the thicker the sample is, the more it scatters electrons.
  - B. Atomic number contrast (Z-contrast): elements with a higher atomic number scatter the electron beam more (e.g. staining of biological samples with dyes containing heavy metals).

2. Diffraction contrast: samples showing arrangement in a crystal lattice generate diffraction.

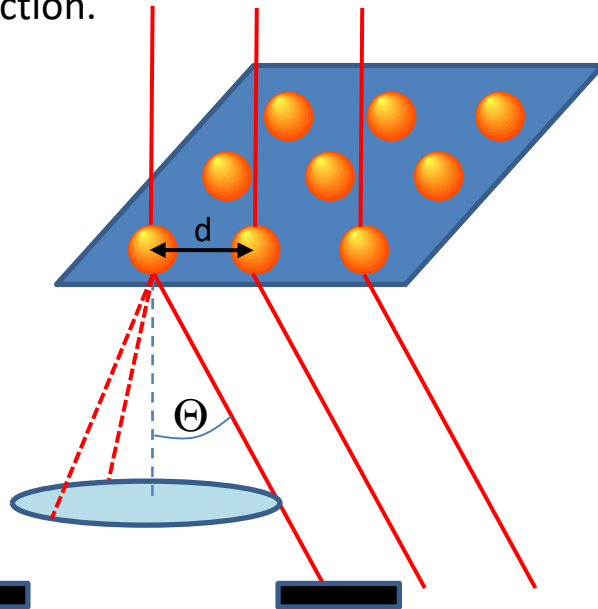

diaphragm

Diffraction is generated in directions for which the following equation holds:

$$n\lambda = 2d \sin \Theta$$

$$\lambda \approx 2d\Theta \leftarrow \text{if the diffraction angle is small}$$

If the angle of diffraction is so large that diffracted electrons collide into the diaphragm, electrons going across sample areas generating diffraction don't take part in image formation.

3. Phase contrast

underfocus:  
atoms are dark

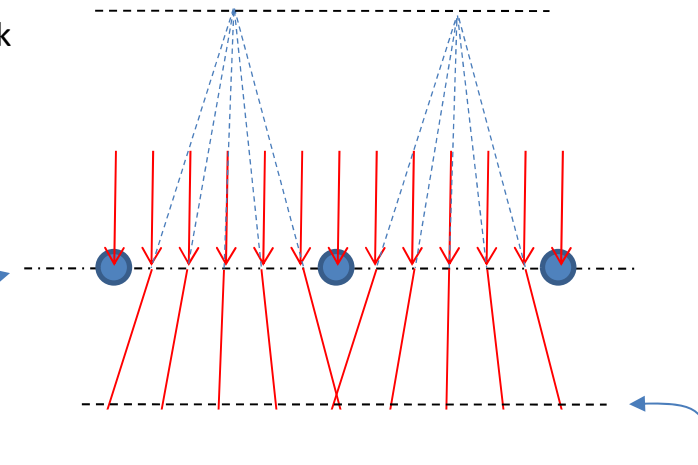

atom plane: if the microscope is focused on this plane, there is no contrast (even distribution of electron beams)

overfocus: atoms are bright

## Electron diffraction

- It is not identical to diffraction contrast appearing in TEM images.
- It can be seen when the lens system of the TEM is adjusted such that the diffraction pattern generated in the back focal plane of the objective is projected on the screen.

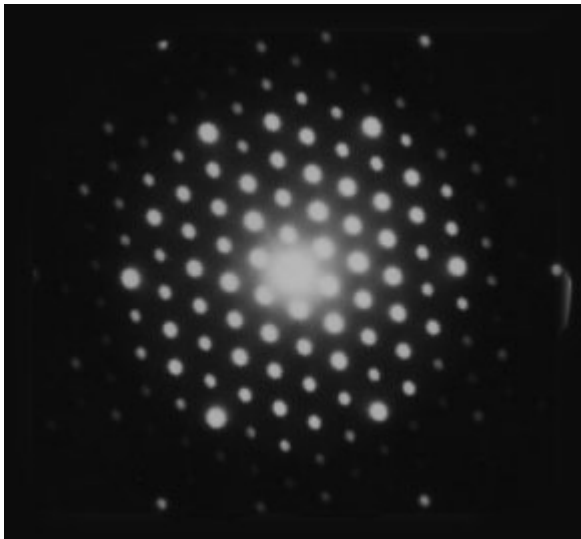

Image showing electron diffraction

- The structure of crystalline material can be calculated from the electron diffraction image.
- Electron diffraction is based on the same principle as X-ray diffraction, but the latter is more accurate.

## Sample preparation for transmission electron microscopy

For biological samples

- sample preparation may be the longest part of the electron microscopic experiment
- sample preparation has a larger impact on the achievable resolution than the physical parameters of the electron microscope (sub-nanometer resolution can theoretically be achieved with electron microscopy, but this is hardly ever possible with biological samples)
- the aim of biological sample preparation is the generation of ultra-thin samples transparent for electron beams
- contrast enhancement with stains containing heavy metals

### Steps of biological sample preparation:

1. Fixation: with glutaraldehyde in most cases
2. Dehydration: water is removed by placing the sample into a series of increasing ethanol or acetone concentrations. Dehydration is required because water would quickly evaporate in the vacuum of TEM damaging the sample. In addition, epoxy resin is hydrophobic, and it can penetrate the sample if water is removed.
3. Embedding: Samples are impregnated by epoxy resin so as to make them solid for cutting.



Samples embedded into epoxy resin.

# Sample preparation for transmission electron microscopy

## Steps of biological sample preparation:

4. Cutting with an ultramicrotome: a glass or a diamond blade cuts slices of ~100 nm thickness, which are allowed to swim on the surface of water.

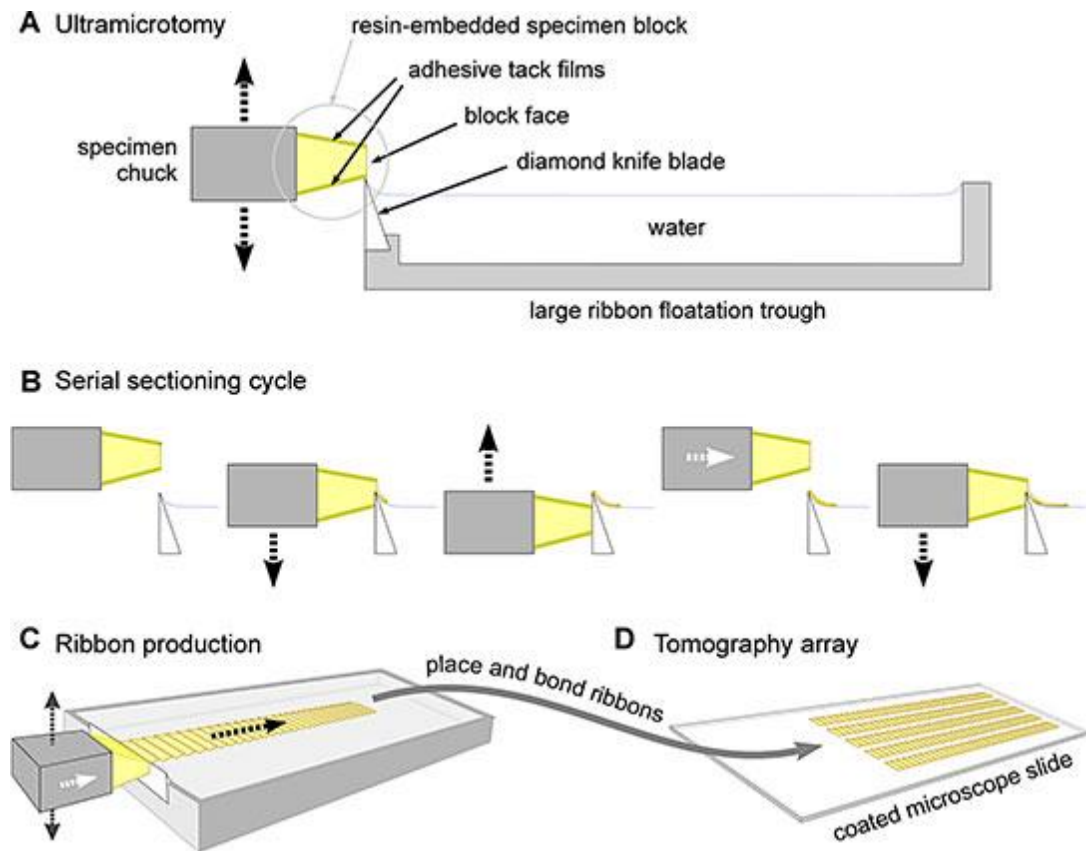

## Sample preparation for transmission electron microscopy

### Steps of biological sample preparation:

5. Samples floating on water are placed on a grid made of copper. The grid is covered by a material transparent for electron beams (Formvar) providing support for the sample. The samples are placed into the electron microscope on the grid. Only those parts of the sample can be investigated with the electron microscope that are above the holes of the grid.

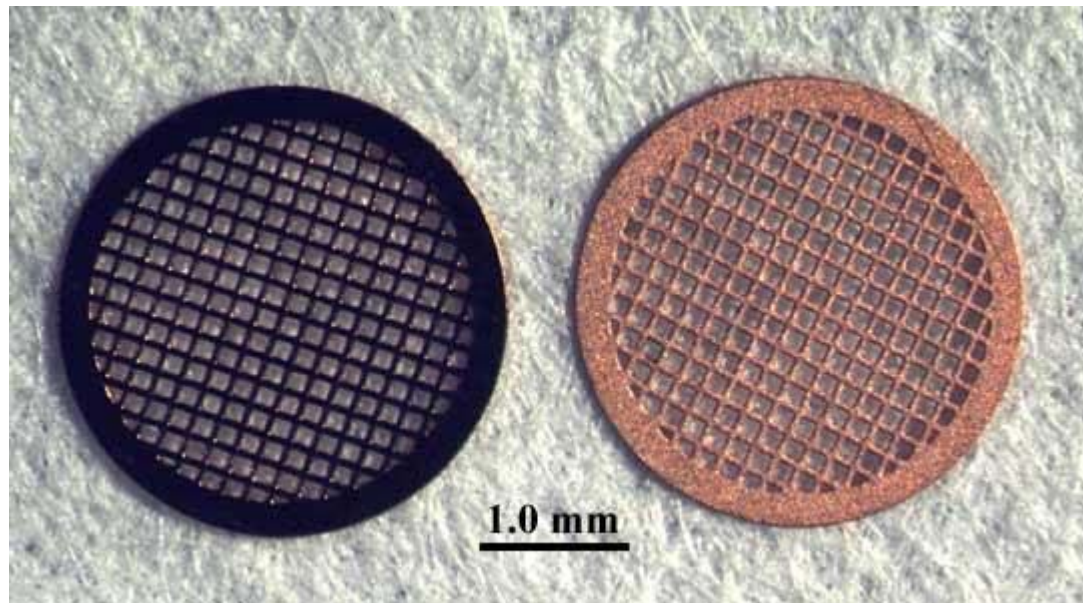

# Sample preparation for transmission electron microscopy

## Steps of biological sample preparation:

6. Staining: it can be performed after putting the sample on the grid or just after fixation.

- Staining is required because biological samples provide very weak contrast (homogenous thickness, homogenous distribution of atomic index).
- During staining the sample is treated with material containing atoms with high atomic number.
- Types of staining:
  - Positive staining: cell organelles are stained (e.g. lead acetate, uranyl acetate).  
Osmium tetroxide stains the lipid component of membranes.
  - Negative staining: leaves organelles preferentially unstained (e.g. phosphotungstic acid).

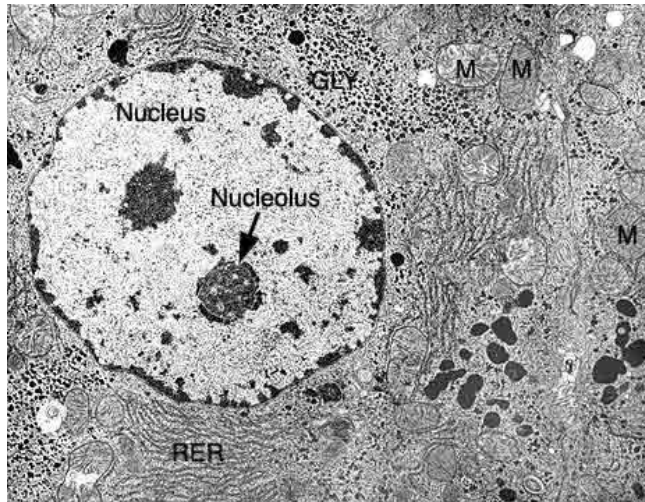



# Sample preparation for transmission electron microscopy

## Other techniques of biological sample preparation

### *immunogold labeling:*

- Antibodies can be adsorbed to colloidal gold particles with a diameter of ~5-30 nm.
- The immunogold particle generated as above specifically binds to molecules the antibody is specific for.
- Colloidal gold particles provide strong contrast in electron microscopic images.
- Colloidal gold with different diameters can be differentiated from each other; therefore, multiple types of proteins can be simultaneously labeled.

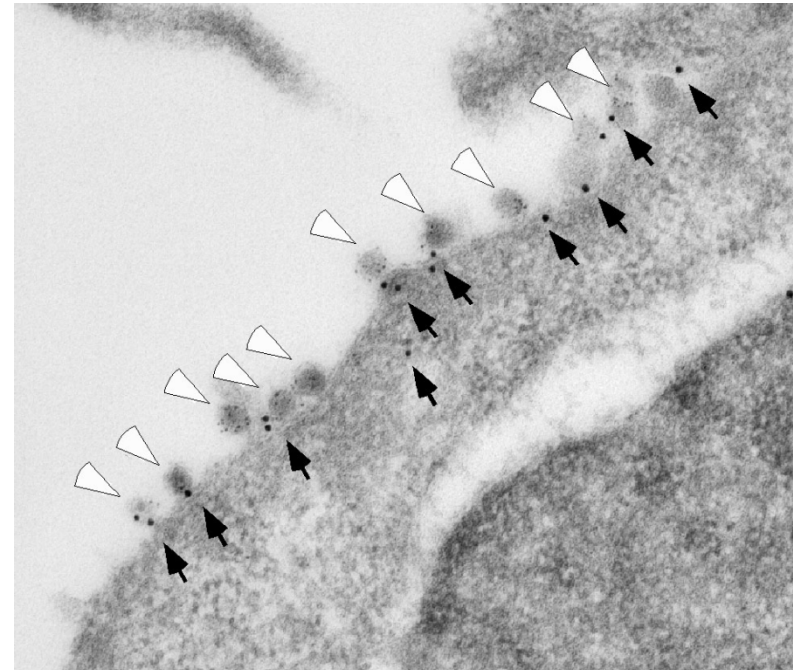
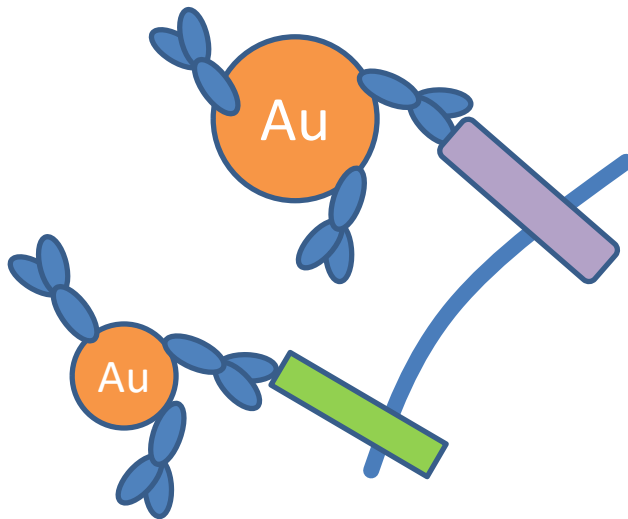

# Sample preparation for electron microscopy

## Other techniques of biological sample preparation

„metal tagging” (METTEM: metal-tagging TEM):

The MT tag is fused to the gene of the protein of interest using molecular biological approaches; therefore, it is present in every copy of the given protein.

unfolded MT tag  
(MT = metallothionein)

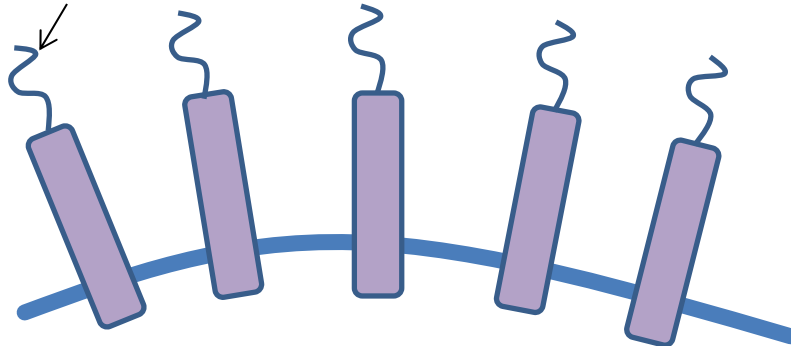

+AuCl or AuCl<sub>3</sub>

MT-gold nanocluster  
(~1 nm)

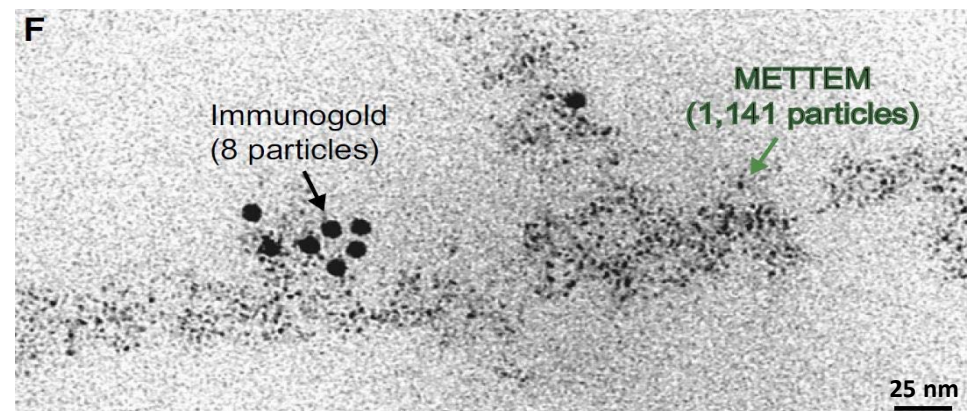
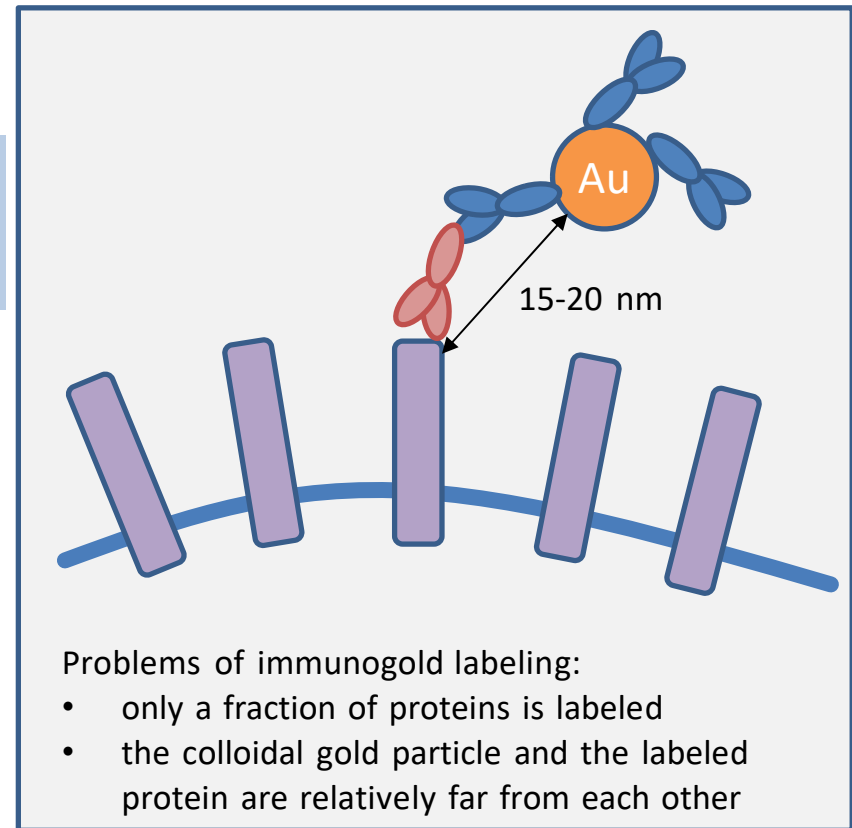
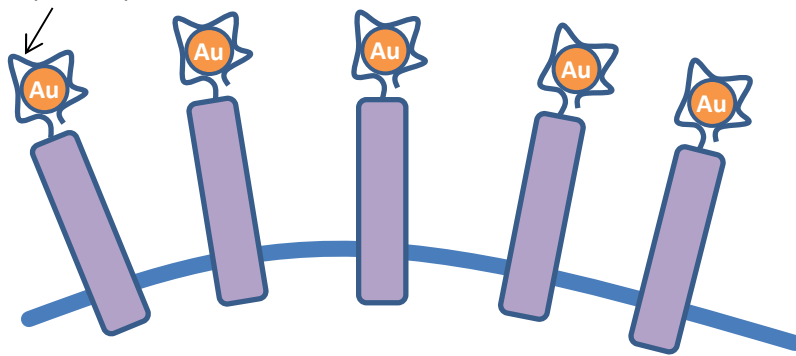

## Sample preparation for electron microscopy

### Other techniques of biological sample preparation

#### APEX labeling:

- APEX: “enhanced” ascorbate peroxidase
  - monomeric
  - high enzymatic activity
  - expressed and folds in the cytosol of eukaryotic cells ( $\leftrightarrow$  horseradish peroxidase, HRP)
  - withstands strong fixation protocols for EM
- APEX fused to proteins will generate osmiophilic polymer that can be stained with  $\text{OsO}_4$

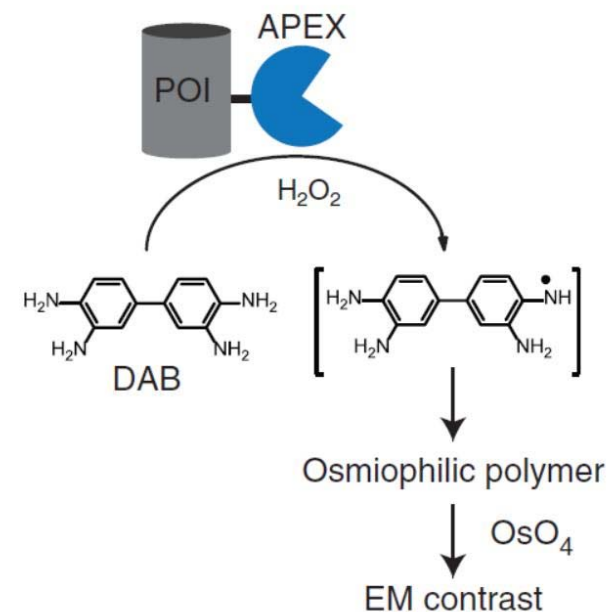
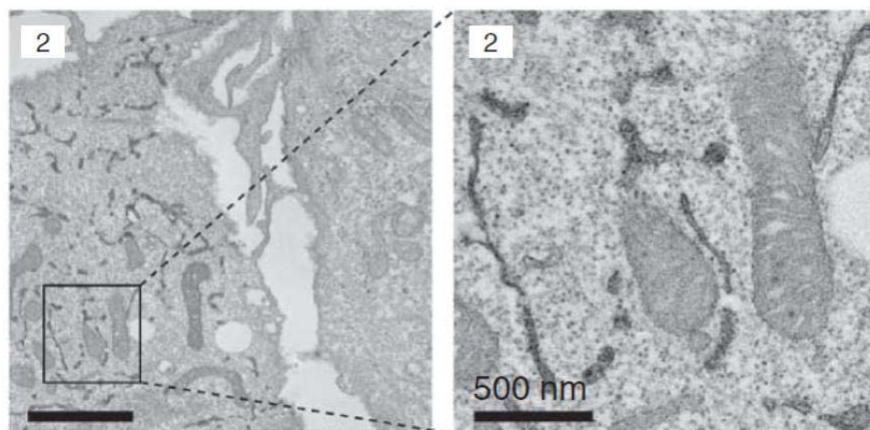

Cells expressing ER-targeted  
APEX-KDEL.

# Sample preparation for transmission electron microscopy

## Other techniques of biological sample preparation

### *surface replica*

- the surface of the sample is coated with a polymer film (replica)
- the replica is thicker where the surface contains grooves
- the replica is removed from the sample and it is investigated by TEM → ultrathin sections are not required
- if the surface contains raised features, the film covers the surface with an equal thickness, but the projected thickness of the replica is larger at oblique surfaces and consequently it appears darker at these pixels (thickness gradient contrast)

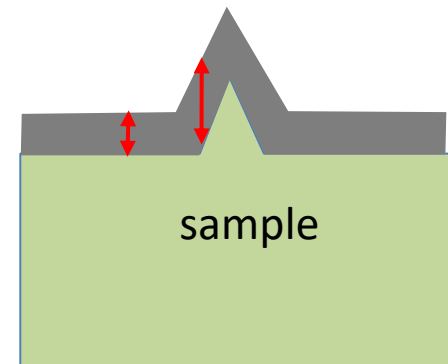

# Sample preparation for transmission electron microscopy

## Other techniques of biological sample preparation

*shadowing:*

- the surface replica provides relatively weak contrast (it is a carbon-containing polymer)
- platinum atoms are evaporated at an oblique angle on to the replica. Raised features present in the replica cast sharp “shadows” within which platinum is absent.

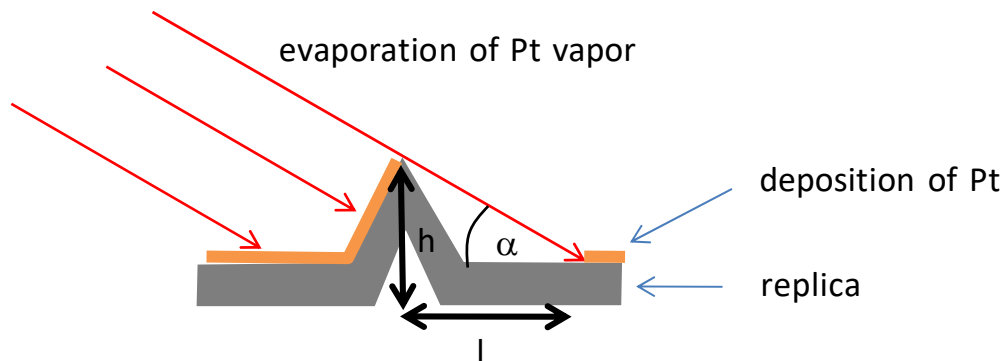

- the height of the raised feature can be estimated from the length of the shadow:

$$\frac{h}{l} = \tan \alpha$$

# Sample preparation for transmission electron microscopy

## Methods for preparing ultrathin sections:

1. Ultramicrotome: for biological and other soft samples
2. Mechanical approach: a slice with a thickness of ~1 mm is cut from which a disk with a diameter of a couple of mm is cut (typically with an ultrasonic drill). The thickness of this disk is further reduced, e.g. by grinding.
3. Chemical thinning: a chemical solution dissolves the original surface and reduces the specimen thickness to a value suitable for TEM imaging.
4. Chemical jet thinning: material reacting with the surface is shot on to the surface.
5. Electrochemical thinning: the thickness of the sample is reduced due to electrolysis.
6. Ion beam thinning: 3mm-diameter thin disk of the material is placed in a vacuum system, where it is bombarded by argon ions produced by a gas discharge within an ion gun. These ions transfer energy to surface atoms and remove the material by the process of sputtering
7. Thin film deposition: the material is evaporated followed by its deposition on to a substrate generating a thin film.

# Scanning electron microscopy: interaction of the electron with the sample

## secondary electron:

- generated by ejection of atomic electrons during inelastic scattering of primary electrons
- its energy is much lower than that of primary electrons

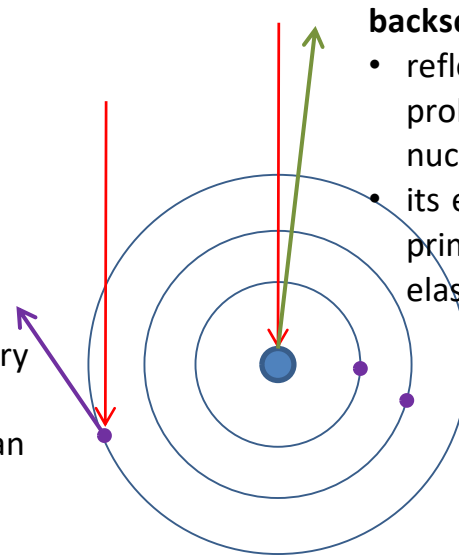

## backscattered electron:

- reflected from nuclei. Generated with a low probability because the diameter of the nucleus is small
- its energy is approximately equal to that of primary electrons because it is generated by elastic scattering

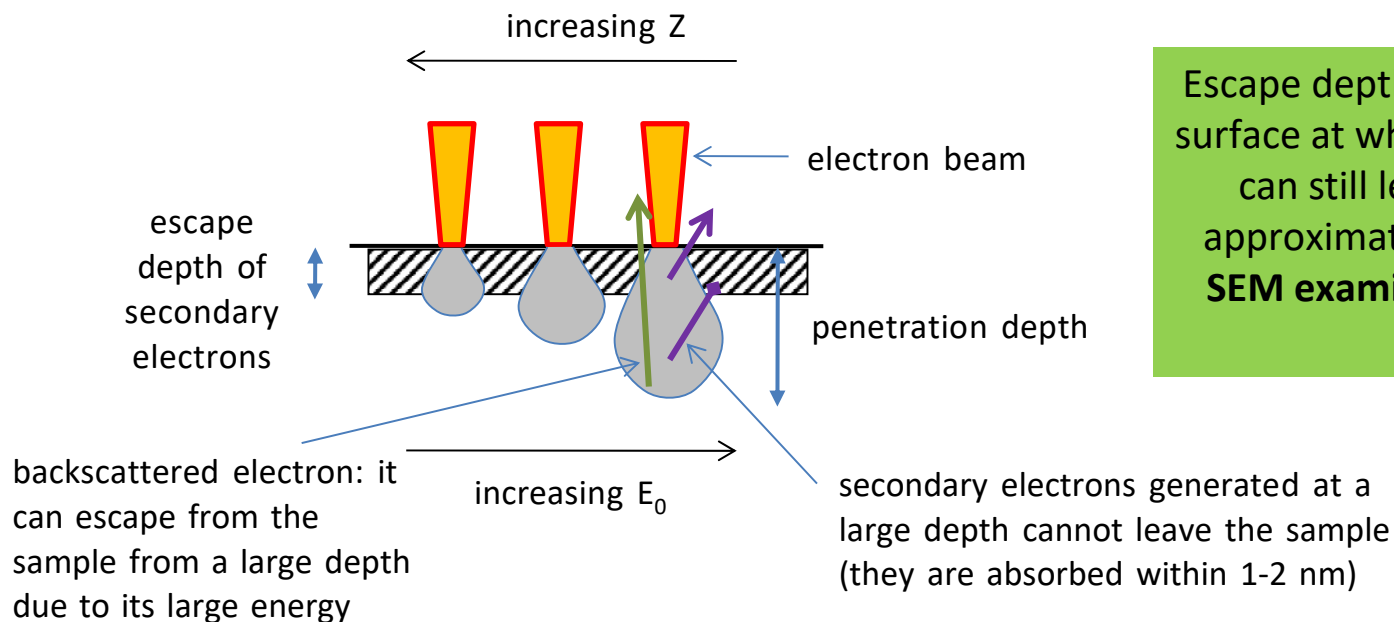

Escape depth: the distance from the surface at which secondary electrons can still leave the sample. It is approximately 1-2 nm. **Therefore, SEM examines the surface of the sample.**

## Factors influencing the generation of secondary electrons

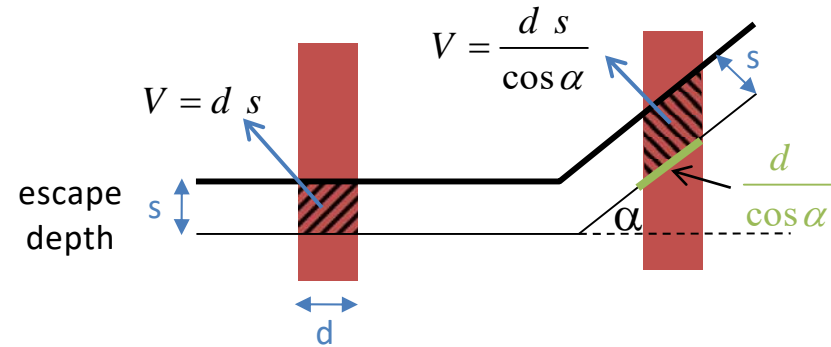
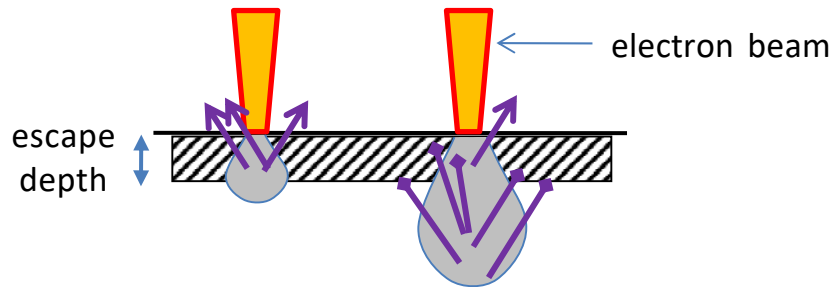

At oblique surfaces the volume from which secondary electrons can escape is larger.



Edges stand out sharply in SEM images



3D effect

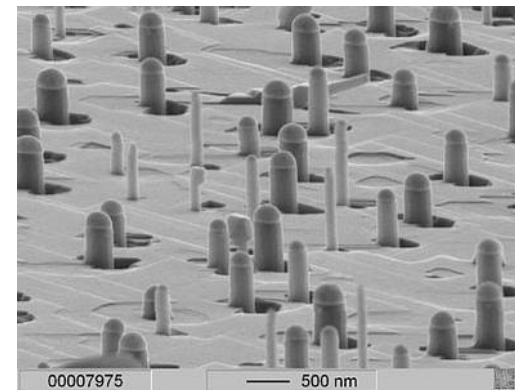

- Secondary electrons are mainly generated by primary electrons which have already slowed down.
- Although more secondary electrons are generated at high primary electron energies, most of the secondary electrons are generated beyond the escape depth.
- At large energies of primary electrons the number of secondary electrons capable of leaving the material decreases.



## Depths at which different signals are generated in SEM

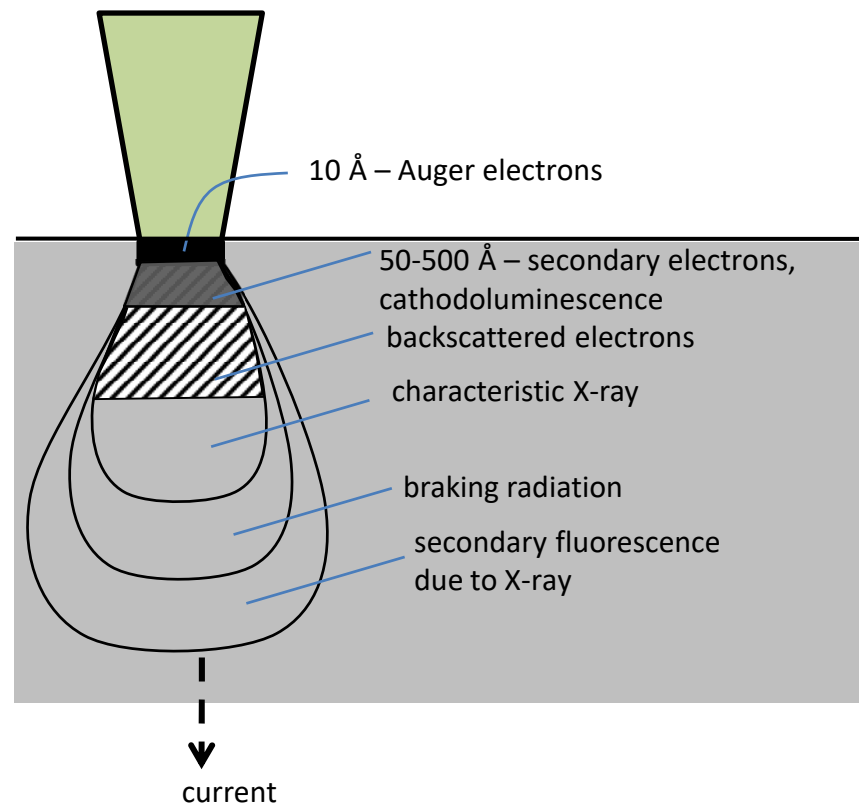

# Backscattered electrons

Backscattered electrons are usually generated as a result of elastic scattering; therefore, their energy is approximately equal to that of primary electrons → **The energy of backscattered electrons is much larger than that of primary electrons.**

The probability of generation of backscattered electrons increases with atomic number → elements with high atomic number are displayed more strongly.

Backscattered electrons can leave the sample from larger depths (↔ secondary electrons can do so only from the surface).

Images generated by backscattered electrons show Z-contrast of thick surface layers of the sample.

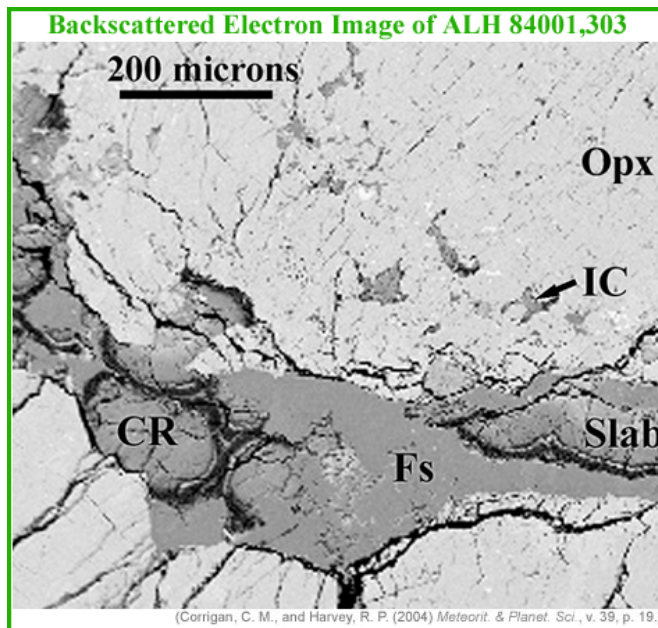

Backscattered electron image of Martian meteorite

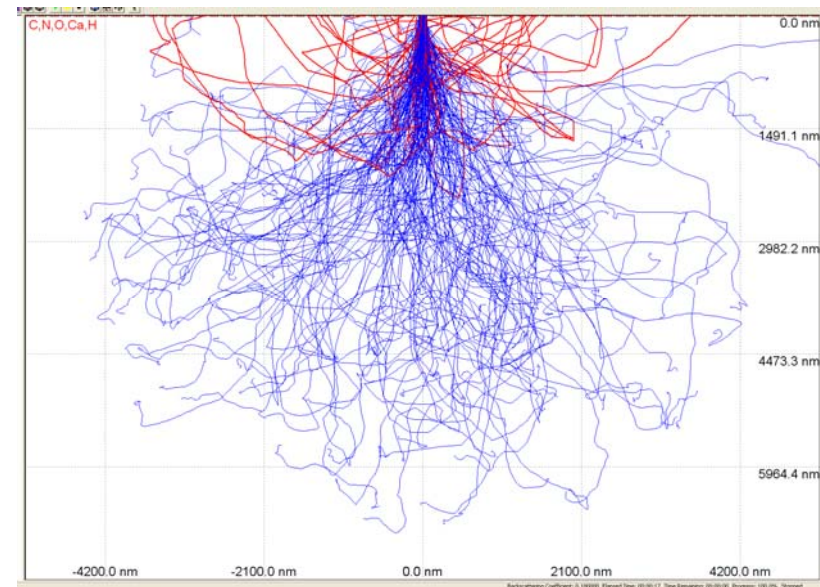

Simulated paths of primary electrons (blue)  
Backscattered electrons (red)  
20 keV

## Other detected signals in SEM

### Specimen current

$$I_{specimen} = I_p - I_{sec} - I_{BSE} = I_p (1 - \eta - \delta)$$

$I_{specimen}$  – current flowing across the specimen

$I_p$  – primary-beam current

$I_{sec}$  – secondary-electron current

$I_{BSE}$  – backscattered-electron current

$\eta$  – probability of generation of secondary electrons

$\delta$  – probability of generation of backscattered electrons

$I_{specimen}$  is characteristic of specimen topography and specimen constitution (Z contrast).

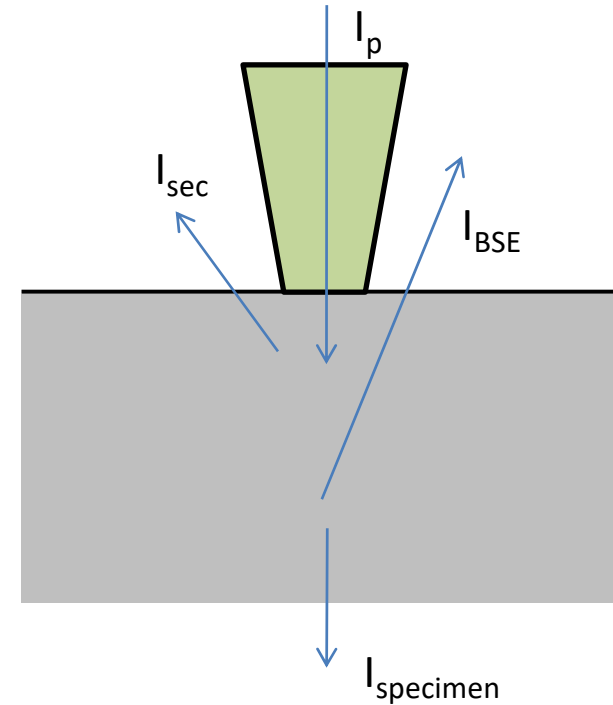

### Cathodoluminescence

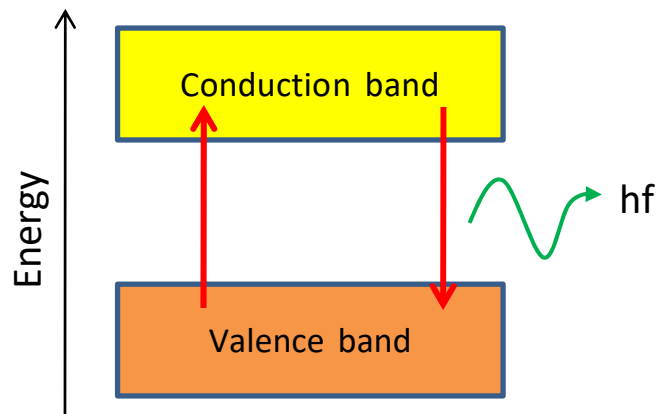

In certain semiconductors impinging electrons move an electron from the valence band to the conduction band. When the excited electron returns to the valence band, it emits fluorescence which is characteristic of the semiconductor.

# Everhart-Thornley detector

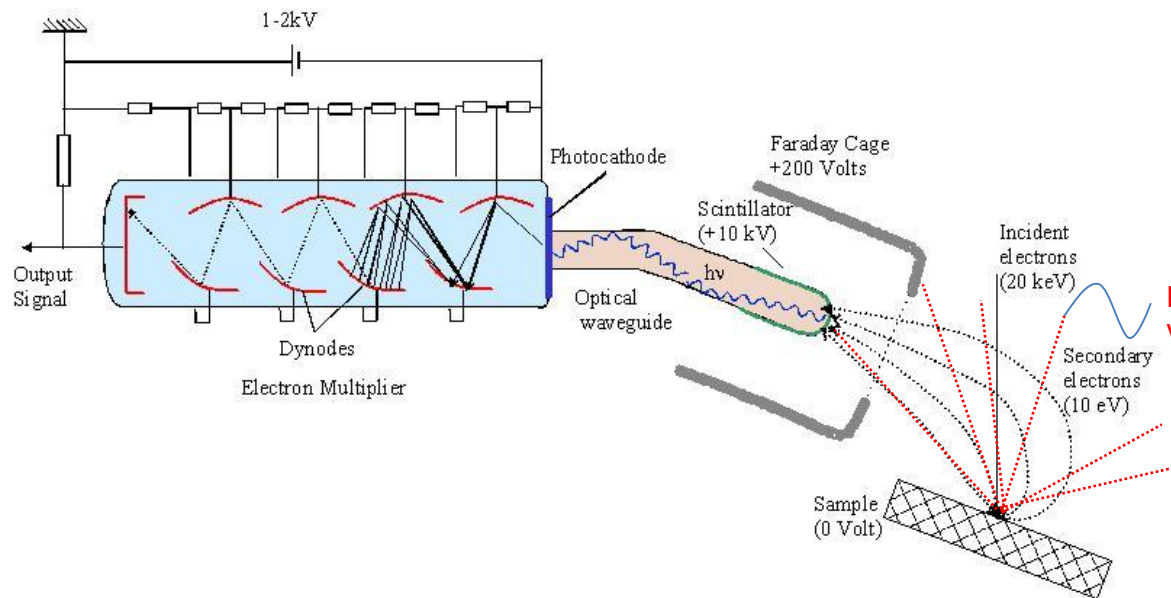

Slow secondary electrons emitted into every direction of space are attracted to the detector by the positive voltage applied to the Everhart-Thornley detector

path of secondary electrons without positive voltage

Collection efficiency of secondary electrons

- in the absence of positive voltage: 5-10%
- in the presence of positive voltage: 90-100%

## Factors deteriorating resolution in SEM

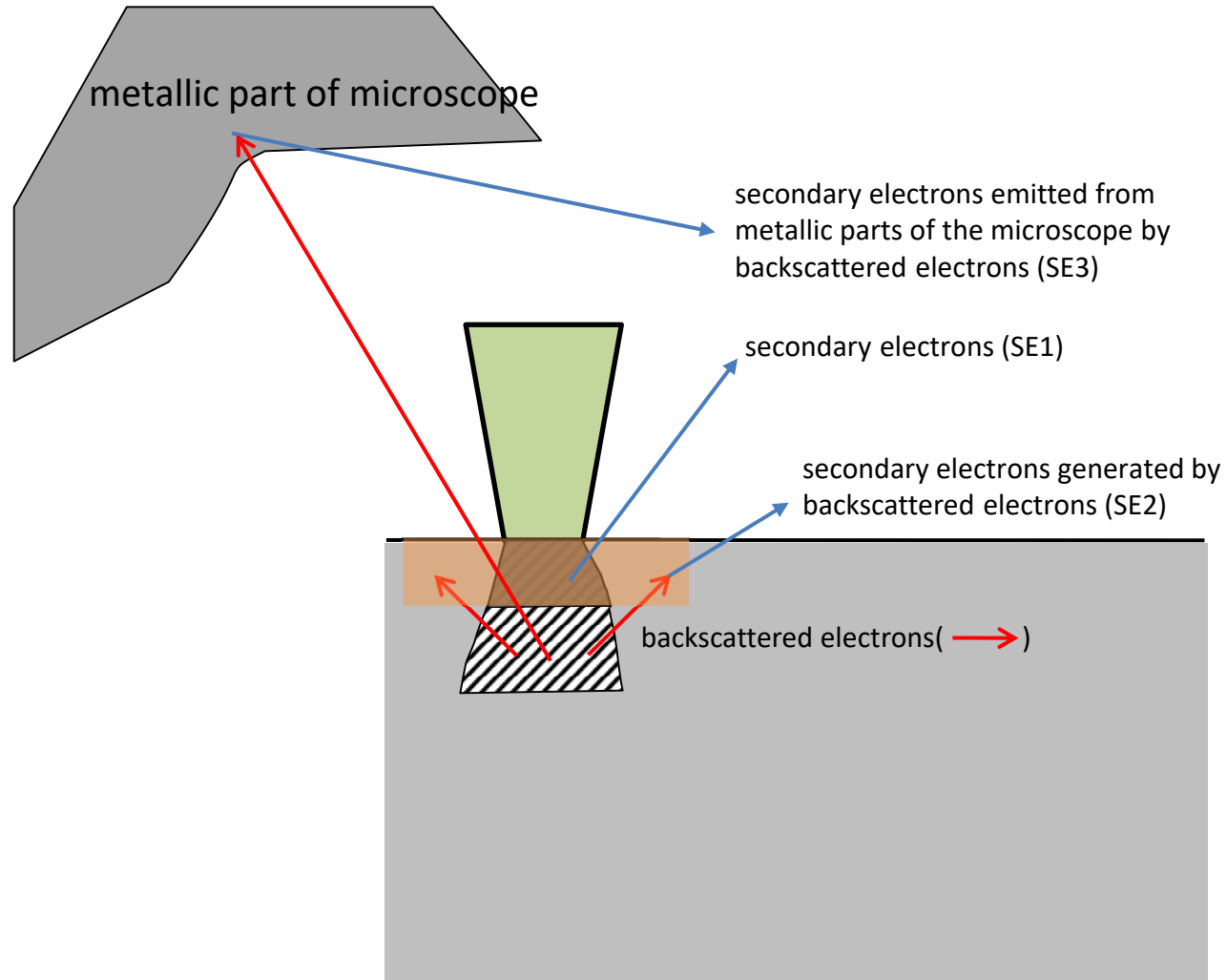

## Sample preparation for SEM

- It is typically much simpler than for TEM since ultrathin sections are not required.
- Problem: the specimen may undergo charging if the specimen current cannot flow to ground.
  - If the specimen is conducting, charging is not a problem.
  - If the specimen is not conducting (like most biological samples), its surface must be coated with a thin film of conducting (metal) material.
  - If coating with metal is not possible, specimen charging can often be avoided by carefully choosing the SEM accelerating voltage so that the charge accumulating in the specimen is approximately zero.

The equation describing specimen current:

$$I_{specimen} = I_p - I_{sec} - I_{BSE} = I_p (1 - \eta - \delta)$$

If  $\eta + \delta = 1$ , charge does not accumulate in the specimen!

Secondary and backscattered electrons are generated deep in the specimen and they cannot escape  $\rightarrow$  electrons accumulate (negative charge).

The energy of primary electrons is low and they cannot generate secondary electrons. Consequently,  $\eta + \delta$  is small  $\rightarrow$  the electrons cannot leave the specimen; therefore it becomes negatively charged due to impinging primary electrons.

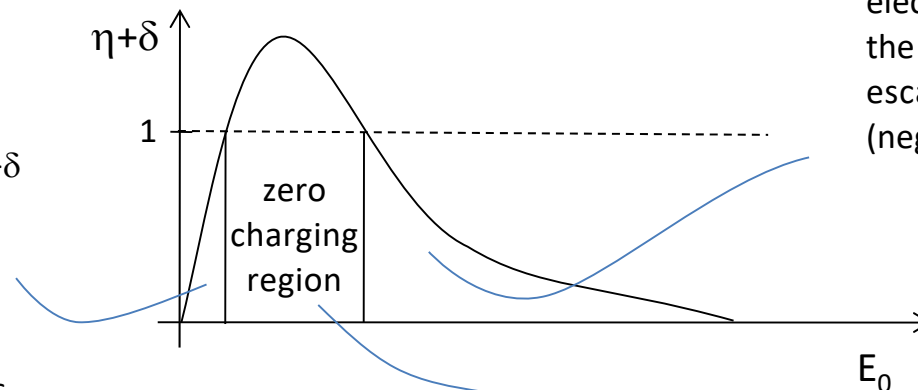

If  $\eta + \delta < 1$ , positive charging takes place, but it is not a problem since positive charge attracts secondary electrons back to the specimen and charge neutrality is restored.

## Electron microscopy with biological samples: special conditions

- **Problems with biological samples:**
  - sensitive, fragile
  - important to retain physiological hydrated conditions
  - prevention of radiation damage
  - all of the above without sacrificing contrast
- **Sample protection (from radiation, damaging effect of fixative):**
  - negative staining: water surrounding the examined protein is replaced by heavy metal salt. In this way the fixative does not damage the protein directly. The metal salt traces the contour of the protein.
  - sealed thin window chamber: the specimen is isolated from the vacuum of the microscope with a thin beryllium foil. In this way the specimen can remain hydrated. 
  - glucose embedding: the water content of the specimen is replaced by glucose. Water molecules bound tightly to proteins remain bound. Disadvantage: the contrast of glucose resembles that of the protein, so it is difficult to differentiate proteins from glucose.
  - environmental EM (discussed later)
  - cryo-EM (discussed later)

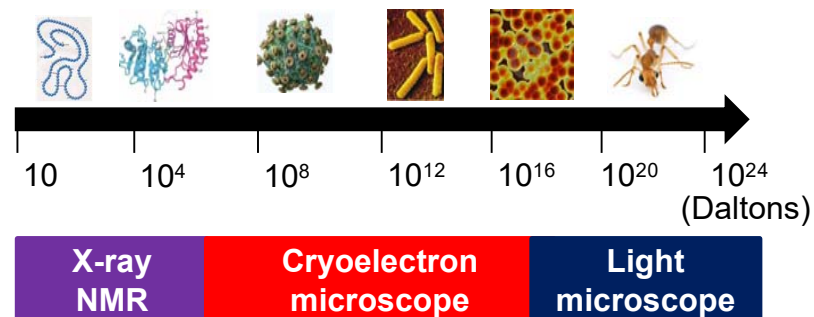

## Cryo-electron microscopy 1

# The Nobel Prize in Chemistry 2017

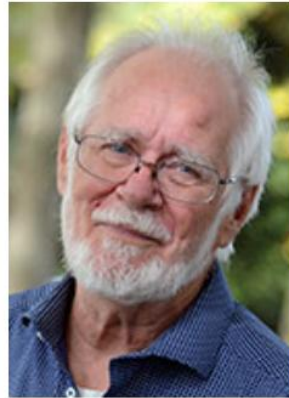

Photo: Félix Imhof © UNIL  
[CC BY-SA 4.0]

**Jacques Dubochet**

Prize share: 1/3



Photo: B. Winkowski ©  
Columbia University  
Medical Center

**Joachim Frank**

Prize share: 1/3



Photo: MRC Laboratory of  
Molecular Biology

**Richard Henderson**

Prize share: 1/3

The Nobel Prize in Chemistry 2017 was awarded to Jacques Dubochet, Joachim Frank and Richard Henderson *"for developing cryo-electron microscopy for the high-resolution structure determination of biomolecules in solution"*.



## Cryo-electron microscopy 2

- **Aim:** the least possible damage of specimens during electron microscopy for structural biology by
  - avoiding the damage done by dehydration, fixation and staining
  - reducing the radiation damage done by the electron beam
- **Sample preparation:** The hydrated sample is frozen suddenly by immersing it into liquid N<sub>2</sub> (77 K = -196°C) or liquid ethane (189 K = -89 °C) in order to prevent the formation of ice crystals. The former applicable to protein samples only, while the latter can also be used for thin biological specimens (cells, viruses, etc.) since ethane
  - does not form vapor on the surface of the specimen (↔liquid N<sub>2</sub>; therefore, the rate of cooling is slower for liquid N<sub>2</sub>)
  - forms a thick condensed layer on the surface of the specimen (↔liquid N<sub>2</sub>; therefore, the rate of cooling is slower with liquid N<sub>2</sub> due to the thin condensed layer formed)
- **The instrument:**

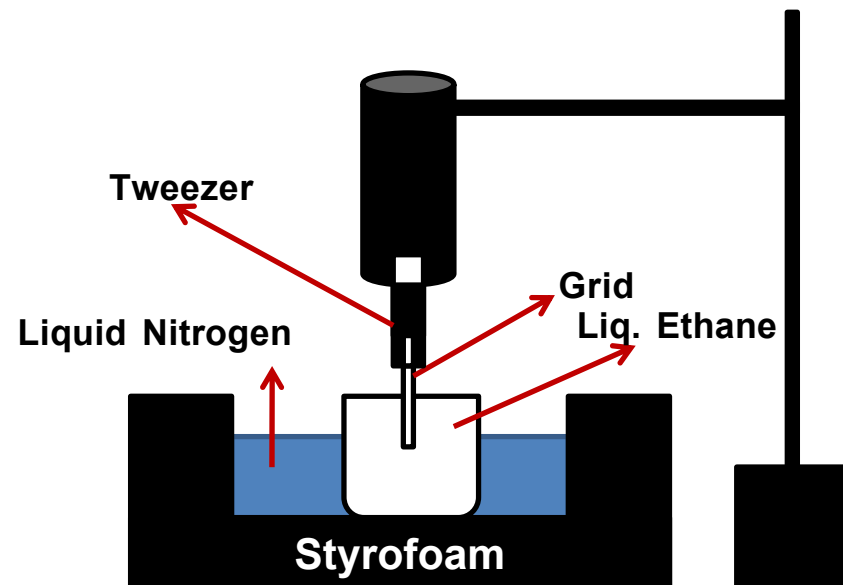

## Cryo-electron microscopy 3

- **Imaging:**

- The specimen is imaged with low intensity radiation in order to minimize radiation damage (→ due to the low number of electrons the quality of images is poor. This is improved by averaging many images).

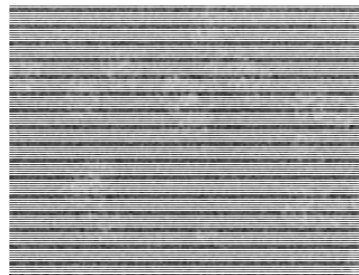

Low resolution image

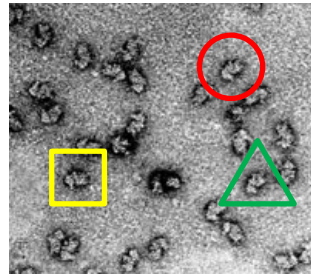

Selection of particles

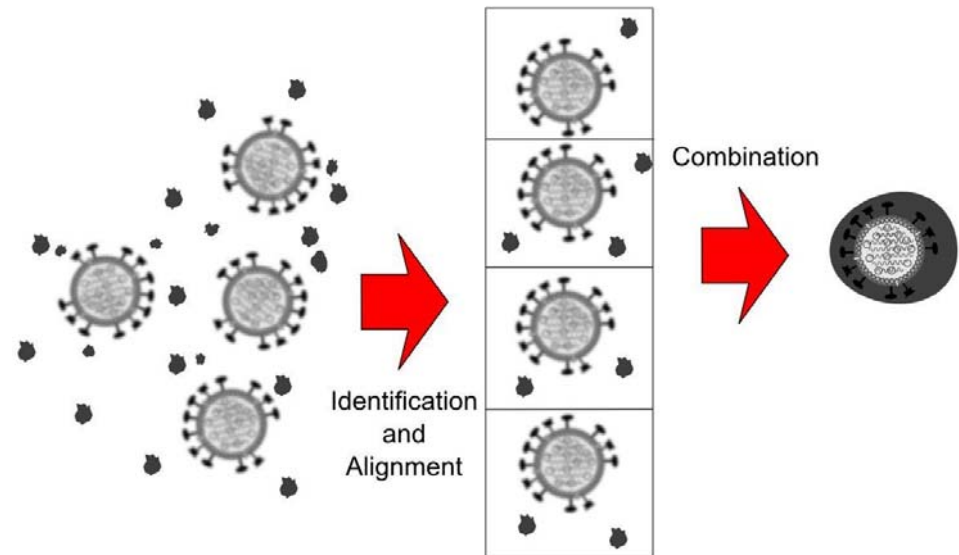

- The specimen is kept at low temperature (~110 K) in the vacuum of the EM
  - in order to prevent the sublimation of non-crystalline water
  - in order to immobilize molecule fragments and free radicals generated by the electron beam and thereby avoid radiation damage.

## Cryo-electron microscopy 4

- Even molecular structures can be revealed by summing a high enough number of images.
  - The smaller a particle, the more difficult it is to align the images. Therefore, structure determination is more of a challenge for small particles.

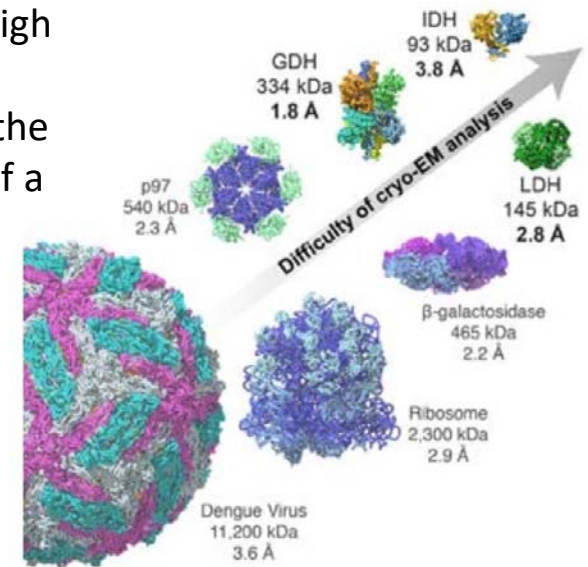

- By investigating the specimen from different directions cryo-electron tomography can be performed.

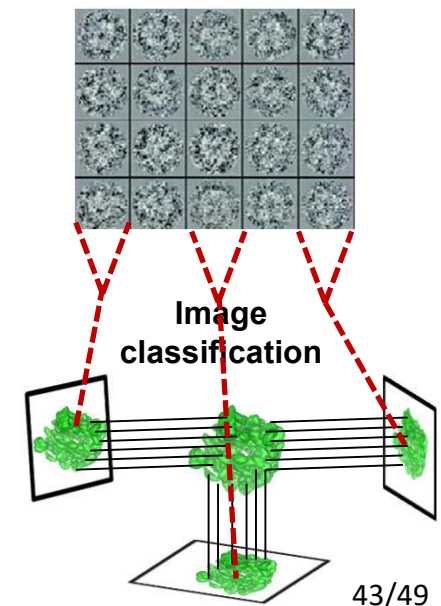

## Environmental SEM

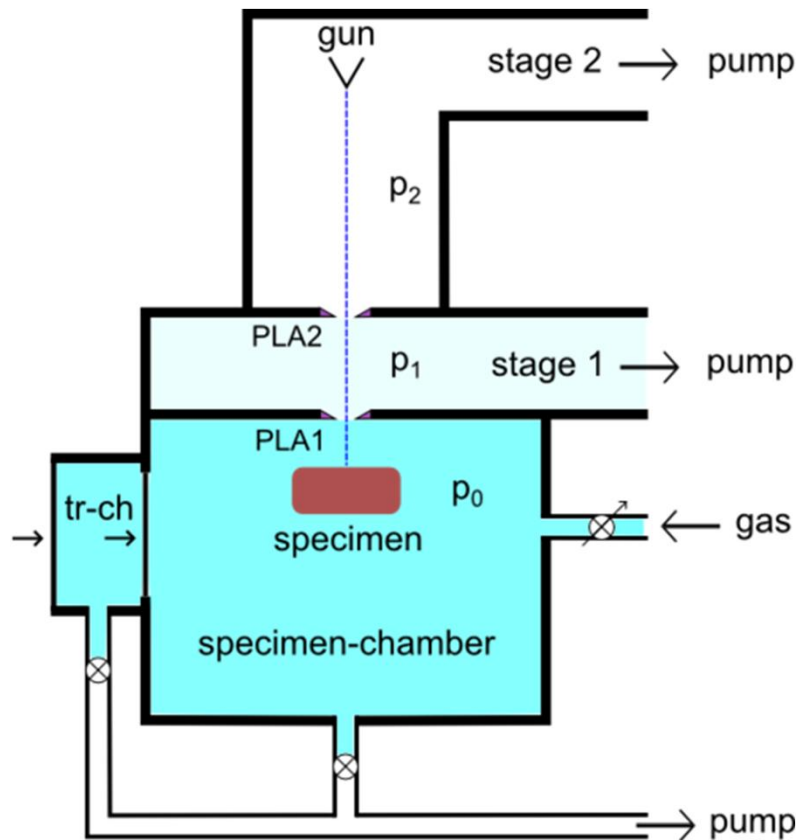

Basic ESEM gas pressure stages

- Such a SEM in which the specimen does not need to be placed in vacuum.
- $p_2 < p_1 < p_0$ , therefore the electron beam can collide with gas molecules only at the end of its path → it is not scattered significantly.
- The specimen is not in vacuum; therefore
  - it is not charged even without coating with metal because negative charge accumulating in the specimen is neutralized by positive ions generated in the gas atmosphere by the electron beam,
  - the specimen does not need to be dehydrated (under a pressure of 609 Pa fluid water does not exist!!! Hydration is important for the intactness of biological samples.)

## Analytical electron microscopy

- Different signals induced by the electron beam contain information about the composition of the specimen and the atomic indices of its constituent elements.
- Analytical electron microscopy is suitable for both qualitative and quantitative determination of elements.
- Signals used for analytical electron microscopy:
  - characteristic X-ray
  - Auger electrons
  - electron energy loss
  - cathodoluminescence (not in the case of biological specimens)

## Generation of characteristic X-ray

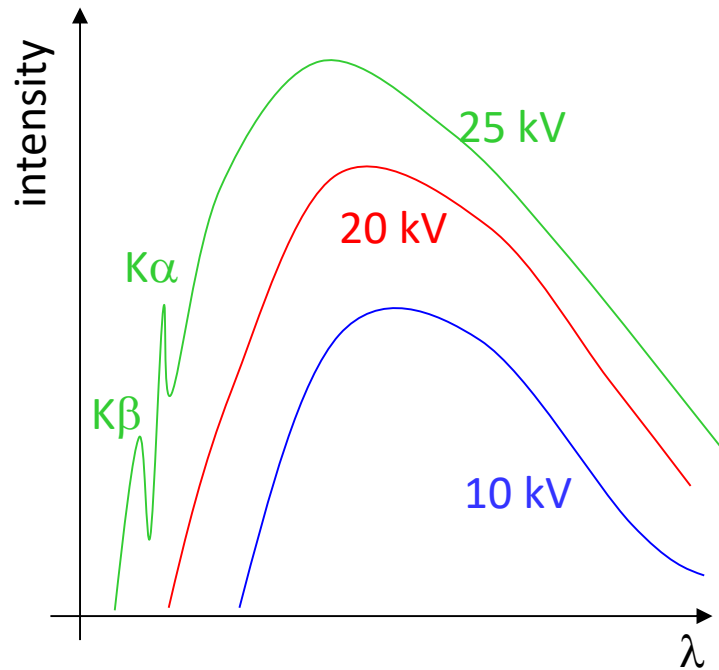

1. the accelerated electron generates a vacancy on an inner shell
2. the vacancy is filled by an electron on a higher shell
3. the energy difference between the two shells is emitted as a photon:

$$hf = E_L - E_K$$

$$E_{kin} = \frac{1}{2}mv^2$$

accelerated electron

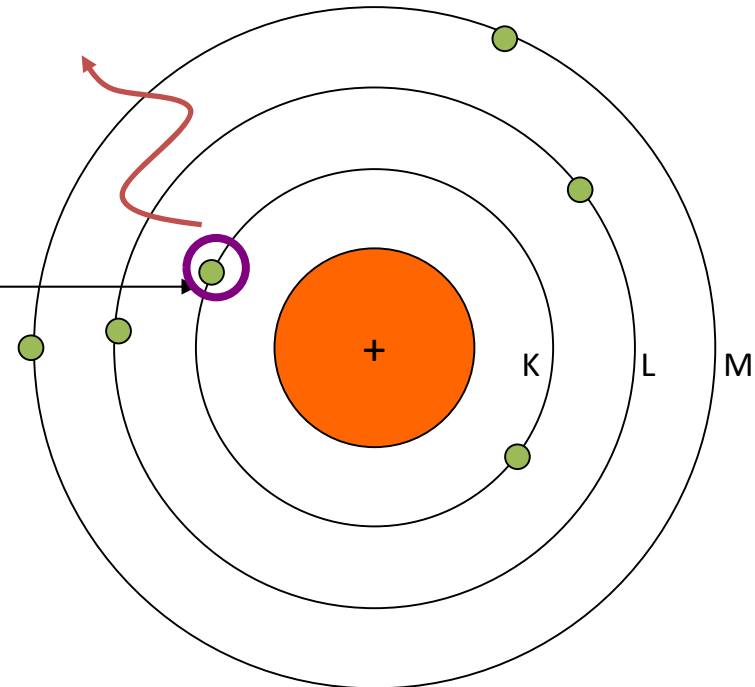

## Generation of Auger electrons

1. The vacancy generated by the accelerated electron is filled from a higher shell.
2. The energy released during the transition isn't converted to a photon, but transferred to a nearby electron which leaves the atom.

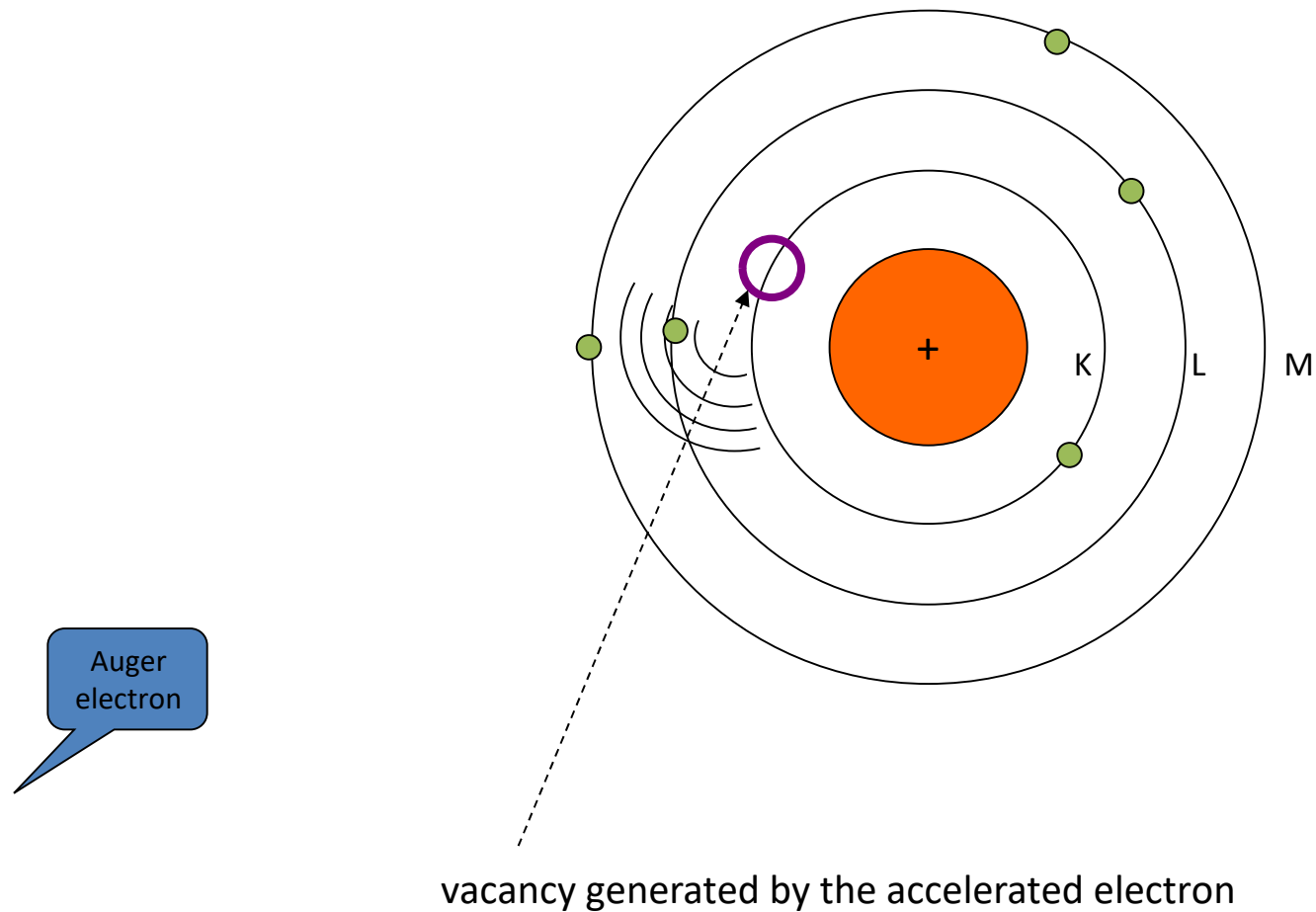

## Analysis of characteristic X-ray

- The wavelength of characteristic X-ray is characteristic of the energy difference between inner electron shells, and its intensity is proportional to the quantity of the given element.
- There are two methods for the spectral analysis of X-ray:

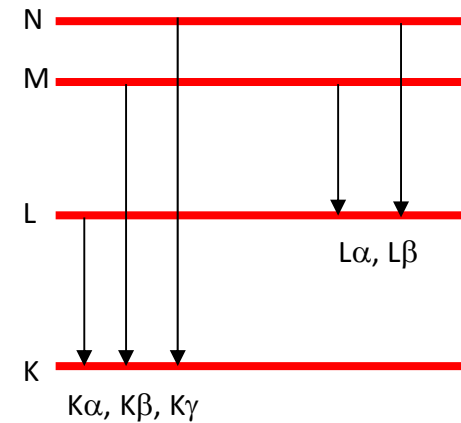

Energy dispersive spectroscopy (XEDS – X-ray energy dispersive spectroscopy; EDAX – energy dispersive analysis of X-ray)

- X-ray photons are detected by a semiconductor diode
- the current impulse generated by the detector is proportional to the energy of the X-ray photon

### ADVANTAGES:

- approximately 1% of emitted X-ray photons are detected, which is much more than in the case of XWDS → fast
- relatively cheap

Wavelength dispersive spectroscopy (XWDS – X-ray wavelength dispersive spectroscopy)

- X-ray photons are deflected to different directions according to their wavelength by a diffraction grating
- the detector always detects X-ray photons with only a certain wavelength

### ADVANTAGES:

- very good wavelength resolution

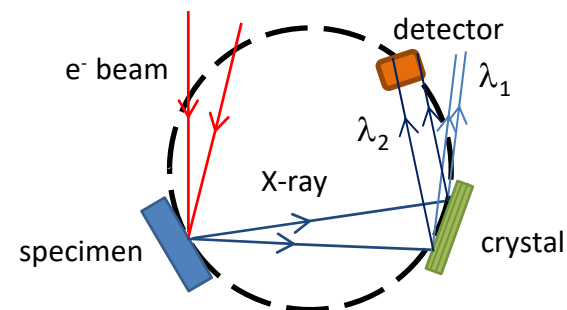



## Auger electron spectroscopy

- In the case of elements with low atomic number the emission of characteristic X-ray has a low yield → these elements cannot be investigated by X-ray spectroscopy.
- On the other hand, Auger electrons are generated with a much higher probability by elements with low atomic number.
- The energy of Auger electrons is characteristic of the given atom.
- Since the energy of Auger electrons is low (<1000 eV), they can be used for analyzing the surface layer of 1 nm thickness.

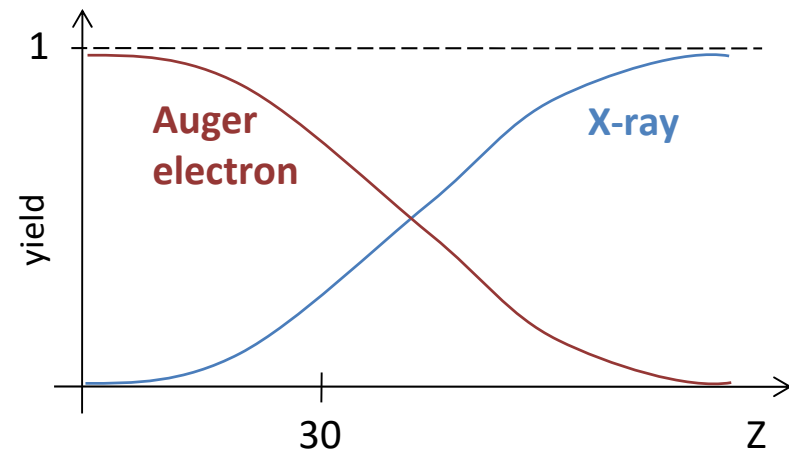

## Electron energy loss spectroscopy (EELS)

- The energy loss of primary electrons going across the specimen is caused, among others, by the generation of vacancies in inner shells of atoms of the specimen (→ characteristic X-ray, Auger electrons).
- Therefore, the energy loss of primary electrons is characteristic of the material of the specimen.
- The energy of primary electrons is measured by magnetic spectrometers.
- It can also be used for the analysis of elements with low atomic number.

